

Smartgen[®]

HGM9520 Genset Parallel (With Mains) Unit

USER MANUAL

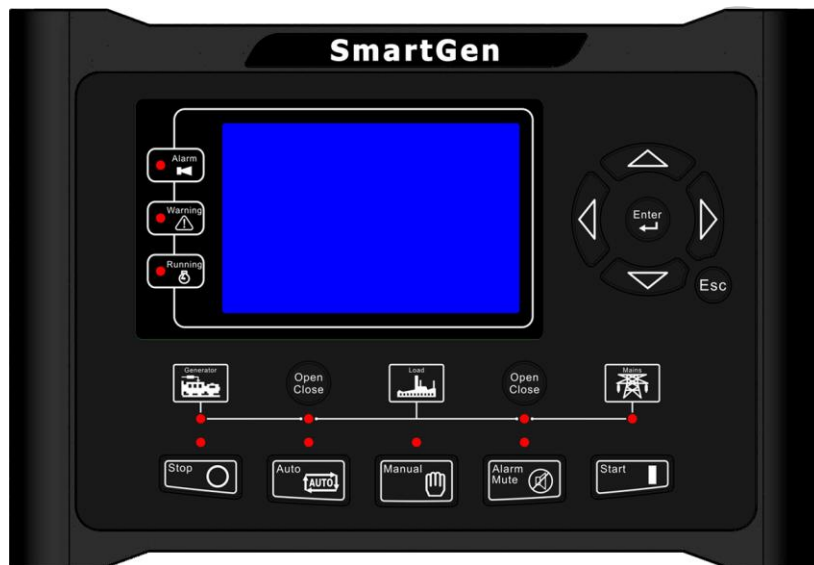

Smartgen Technology

CONTENTS

1	OVERVIEW	5
2	MODULES COMPARISON	6
3	PERFORMANCE AND CHARACTERISTICS	7
4	SPECIFICATION	9
5	OPERATION	10
5.1	INDICATOR LIGHT	10
5.2	PUSHBUTTONS	11
5.3	LCD DISPLAY	12
5.3.1	MAIN DISPLAY	12
5.3.2	USER MENU AND PARAMETERS SETTING MENU	14
5.4	AUTO START/STOP OPERATION	17
5.5	MANUAL START/STOP OPERATION	18
5.6	SWITCH CONTROL PROCEDURES.....	19
5.6.1	MANUAL TRANSFER PROCEDURES	19
5.6.2	AUTOMATIC CONTROL PROCEDURE	19
6	PROTECTIONS.....	20
6.1	WARNING ALARMS.....	20
6.2	SHUTDOWN ALARMS.....	22
6.3	TRIP AND STOP ALARMS.....	24
6.4	TRIP ALARM	25
7	WIRING CONNECTION	26
8	SCOPES AND DEFINITIONS OF PROGRAMMABLE PARAMETERS.....	29
8.1	CONTENTS AND SCOPES OF PARAMETERS.....	29
8.2	PROGRAMMABLE OUTPUT PORTS.....	39
8.2.1	DEFINED PERIOD OUTPUT.....	43
8.2.2	DEFINED COMBINATION OUTPUT.....	43
8.3	PROGRAMMABLE INPUT PORTS (ALL ACTIVE WHEN CONNECT TO GRAND (B-))	45
8.4	SELECTION OF SENSORS.....	47
8.5	CONDITIONS OF CRANK DINSCONNECT SELECTION	48
9	PARAMETERS SETTING.....	49
10	SENSORS SETTING	50
11	COMMISSIONING.....	51
11.1	STEP 1. GENSET DEBUGGING.....	51
11.2	STEP 2: MANUAL PARALLEL OPERATION OFF-LOAD	51
11.3	STEP 3: MANUAL PARALLEL OPERATION ON-LOAD	51
12	MAINS PARALLEL.....	52
12.1	GENSET CONTROL MODE.....	52
12.2	MAINS CONTROL MODE	53
12.3	LOAD TAKEOVER MODE.....	54
12.4	AMF MODE	55
12.5	ISLAND MODE	56

13 TYPICAL APPLICATION.....	57
14 INSTALLATION	58
15 CONNECTIONS OF CONTROLLER WITH J1939 ENGINE.....	60
15.1 CUMMINS ISB/ISBE.....	60
15.2 CUMMINS QSL9	60
15.3 CUMMINS QSM11 (IMPORT)	61
15.4 CUMMINS QSX15-CM570	61
15.5 CUMMINS GCS-MODBUS.....	62
15.6 CUMMINS QSM11	62
15.7 CUMMINS QSZ13	63
15.8 DETROIT DIESEL DDEC III / IV	63
15.9 DEUTZ EMR2.....	64
15.10 JOHN DEERE.....	64
15.11 MTU MDEC	64
15.12 MTU ADEC(SMART MODULE).....	65
15.13 MTU ADEC(SAM MODULE)	65
15.14 PERKINS.....	66
15.15 SCANIA	66
15.16 VOLVO EDC3.....	66
15.17 VOLVO EDC4.....	67
15.18 VOLVO-EMS2	67
15.19 YUCHAI.....	68
15.20 WEICHAI	68
16 USB.....	69
17 FAULT FINDING.....	70

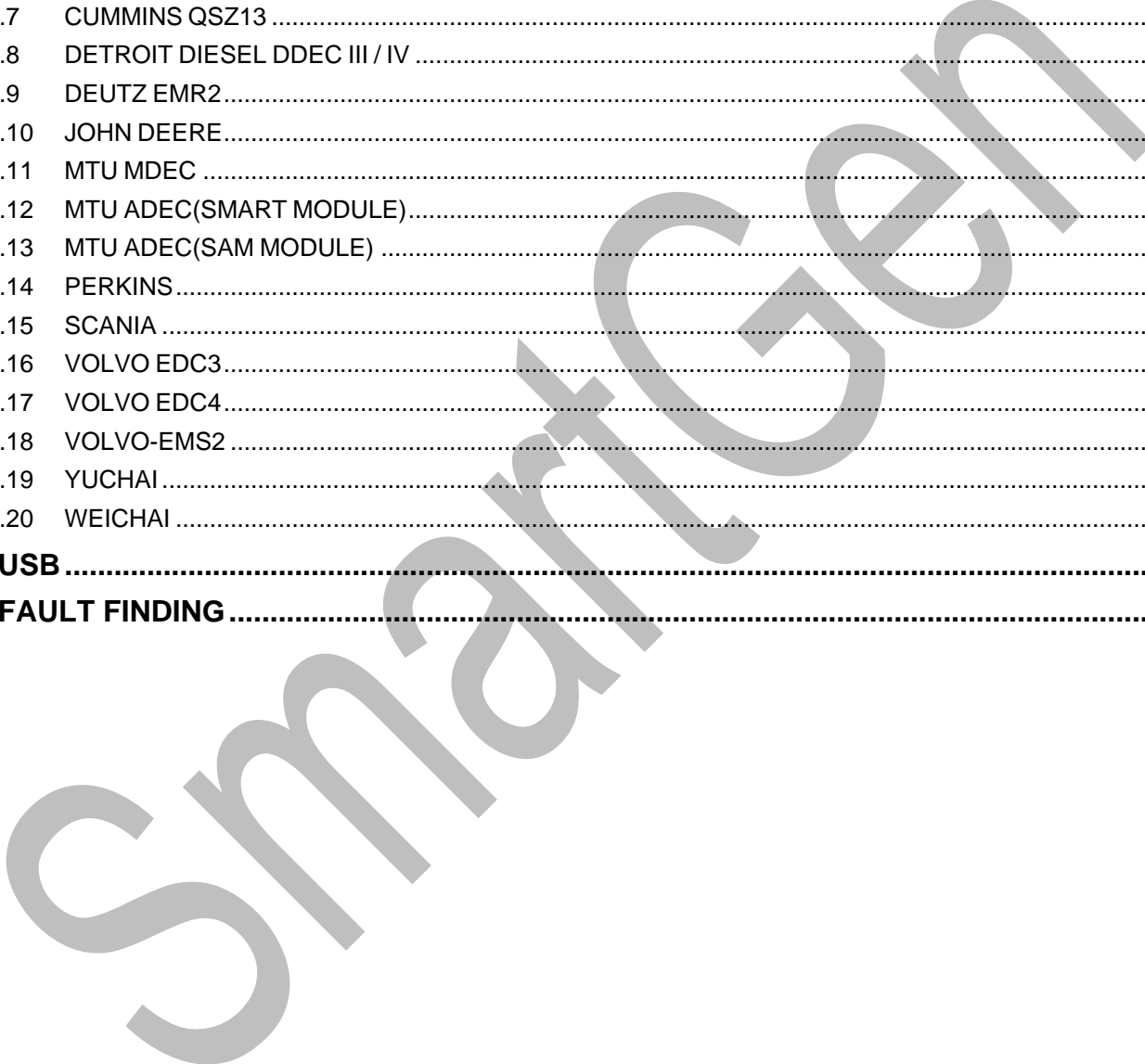

1 OVERVIEW

HGM9520 controller is designed for manual/auto parallel systems generators. The controller allows automatic start/stop, data measurement, alarm protection as well as remote control, remote measurement and remote communication. It has LCD display, selectable Chinese, English and other languages interface, and it is reliable and easy to use.

HGM9520 controller integrates GOV (Engine Speed Governor) and AVR (Automatic Voltage Regulator) control functions. Multiple working modes can be selected, such as genset fixed active power, reactive power/power factor output, mains peak lopping and uninterruptedly restore to mains supply.

HGM9520 controller can accurately monitor multiple running states of the gen-set. When gen-set abnormal condition occurs, it splits bus and shuts down the gen-set; simultaneously the fault condition appears on LCD. HGM9520 controller has SAE J1939 interface that can communicate with a number of ECU (ENGINE CONTROL UNIT) which equip with J1939.

HGM9520 controller adopt 32 bits micro-processor technology with precision parameters measuring, fixed value adjustment, time setting and set value adjusting and etc..Majority parameters can be configured from front panel, and all parameters can be configured by USB interface (or RS485) to adjust via PC. It can be widely used in all types of automatic gen-set control system with compact structure, advanced circuits, simple connections and high reliability.

2 MODULES COMPARISON

		HGM 9210	HGM 9220	HGM 9310	HGM 9320	HGM 9410	HGM 9420	HGM 9610	HGM 9620	HGM 9510	HGM 9520
LCD	Dimension	3.7"						4.3"			
	pixel	132 x 64						480 x 272			
AMF			•		•		•		•		•
BUS Monitoring										•	
Parallel connection										•	•
Expansion module								•	•		
Input Ports		7	7	7	7	7	7	8	8	7	7
Output Ports		8	8	8	8	8	8	8	8	8	8
Sensor Number		5	5	5	5	5	5	5	5	5	5
Neutral (Earth) current								•	•		
Scheduled function		•	•	•	•	•	•	•	•	•	•
ETHERNET								•	•		
RS485				•	•	•	•	•	•	•	•
GSM				•	•	•	•	•	•		
J1939						•	•	•	•	•	•
USB		•	•	•	•	•	•	•	•	•	•
LINK		•	•								
Real-time clock		•	•	•	•	•	•	•	•	•	•
Event log		•	•	•	•	•	•	•	•	•	•
Micro SD card								•	•		

▲ NOTE:

- (1) Two of the outputs are fixed: start output and fuel output.
- (2) HGM9510's analog sensors are composed by 3 fixed sensors (temperature, pressure, level) and 2 configurable sensors.

▲ NOTE:

The controller features of HGM9210/HGM9220/HGM9310/HGM9320/HGM9410/HGM9420/HGM9510/ HGM9610/HGM9620 mentioned in this document may change, please check the corresponding user manual for accurate information.

3 PERFORMANCE AND CHARACTERISTICS

- With ARM-based 32-bit SCM, high integration of hardware and more reliable;
- 480x272 LCD with backlight, multilingual interface (including English, Chinese or other languages) which can be chosen at the site, making commissioning convenient for factory personnel;
- Improved LCD wear-resistance and scratch resistance due to hard screen acrylic;
- Silicon rubber panel and pushbuttons for better operation in high/low temperature environment;
- RS485 communication port enables remote control, remote measuring, remote communication via ModBus protocol.
- Equipped with CANBUS port and can communicate with J1939 genset. Not only can you monitoring frequently-used data (such as water temperature, oil pressure, speed, fuel consumption and so on) of ECU machine, but also control start, stop , raising speed and speed droop via CANBUS port.
- Suitable for 3-phase 4-wire, 3-phase 3-wire, single phase 2-wire, and 2-phase 3-wire systems with voltage 120/240V and frequency 50/60Hz;
- Collects and shows 3-phase voltage, current, power parameter and frequency of mains/generator.

Mains

Line voltage (Uab, Ubc, and Uca)

Phase voltage (Ua, Ub, and Uc)

Phase sequence

Frequency (Hz)

Current IM

Active power kW

Reactive power kVar

Apparent power kVA

Power factor PF

Rate of Change of Frequency ROCOF

Vector Shift VS

Generator

Line voltage (Uab, Ubc, and Uca)

Phase voltage (Ua, Ub, and Uc)

Phase sequence

Frequency (Hz)

Current IA, IB, IC

Each phase and total active power kW

Each phase and total reactive power kVar

Each phase and total apparent power kVA

Each phase and average power factor PF

Accumulate total gen power kWh、kVarh、kVAh

Earth current and percentage

Negative Sequence Current and percentage

- Perfect mains split protection: over/under frequency, over/under voltage, ROCOF and vector shift;
- For generator, controller has over and under voltage, over and under frequency, loss of phase, phase sequence wrong, over and reverse power, over current protection functions;

- Synchronization parameters :Voltage Difference between generator and mains ,Frequency Difference between generator and mains , Phase Difference between generator and mains ;
- Multiple operation modes in auto state: AMF (Automatic Mains Failure), Island Mode, Fixed Power, Peak Lopping Mode and Load Takeover Mode;
- Ramp on and ramp off function;
- 3 fixed sensors (temperature, oil pressure and liquid level);
- 2 configurable sensors can be set as temperature sensor, oil pressure sensor or fuel level sensor;
- More kinds of curves of temperature, oil pressure, fuel level can be used directly and users can define the sensor curves by themselves ;
- Precision measure and display parameters about Engine,

Temp. (WT)	°C/°F both be displayed
Oil pressure (OP)	kPa/Psi/Bar all be displayed
Fuel level (FL)	% (unit)
Speed (SPD)	r/min (unit)
Voltage of Battery (VB)	V (unit)
Voltage of Charger (VD)	V (unit)

Hour count (HC) can accumulate Max. 65535 hours.
Start times can accumulate Max. 65535 times
- Control and protection: automatic start/stop of the diesel genset, ATS(Auto Transfer Switch) control with perfect fault indication and protection function;
- All output ports are relay output;
- Parameter setting: parameters can be modified and stored in internal EEPROM memory and cannot be lost even in case of power outage; most of them can be adjusted using front panel of the controller and all of them can be modified using PC via USB or RS485 ports;
- Multiple crank disconnect conditions (speed sensor, oil pressure, generator frequency) are optional;
- Widely power supply range DC(8~35)V, suitable to different starting battery voltage environment;
- Event log, real-time clock, scheduled start & stop generator (can be set as start genset once a day/week/month whether with load or not);
- Accumulative total run time and total electric energy of A and B. Users can reset it as 0 and re-accumulative the value which make convenience to users to count the total value as their wish.
- Can control engine heater, cooler and fuel pump.
- With maintenance function. Actions (warning, trip and stop, shutdown) can be set when maintenance time out;

- All parameters used digital adjustment, instead of conventional analog modulation with normal potentiometer, more reliability and stability;
- IP55 waterproofness level can be achieved with the help of rubber-ring gasket between shell and control panel.
- Metal fixing clips enable perfect in high temperature environment ;
- Modular design, anti-flaming ABS plastic shell, pluggable terminal, built-in mounting , compact structure with easy installation ;

4 SPECIFICATION

Parameter	Details
Working Voltage	DC8. 0V to 35. 0V, uninterruptible power supply
Overall Consumption	<4W (Standby mode: ≤2W)
AC Input:	
3 Phase 4 Wire	AC 15V - 360V (ph-N)
3 Phase 3 Wire	AC 30V - 620V (ph-ph)
Single Phase 2 Wire	AC 15V - 360V (ph-N)
2 Phase 3 Wire	AC 15V - 360V (ph-N)
Alternator Frequency	50Hz/60Hz
Speed Sensor Voltage	1. 0 V to 24 V (RMS)
Speed Sensor Frequency	Maximum 10,000 Hz
Start Relay Output	16 Amp DC28V power supply output
Fuel Relay Output	16 Amp DC28V power supply output
Configurable Relay Output 1	7 Amp DC28V power supply output
Configurable Relay Output 2	7 Amp DC28V power supply output
Configurable Relay Output 3	7 Amp DC28V power supply output
Configurable Relay Output 4	7 Amp AC250V passive output
Configurable Relay Output 5	7 Amp AC250V passive output
Configurable Relay Output 6	7 Amp AC250V passive output
Case Dimensions	266mm x 182mm x 45mm
Panel Cutout	214mm x 160mm
CT Secondary Current	Rated 5A
Working Conditions	Temperature: (-25~+70)°C Humidity: (20~93)%RH
Storage Conditions	Temperature:(-30~+80)°C
Protection Level	IP55: when waterproof rubber gasket installed between the controller and panel fascia. IP42: when waterproof rubber gasket is NOT installed between the controller and panel fascia.
Insulation Intensity	Object: input/output/power supply Quote standard: IEC688-1992 Test method: AC1.5kV/1min Leakage current: 3mA
Weight	0.95kg

5 OPERATION

5.1 INDICATOR LIGHT

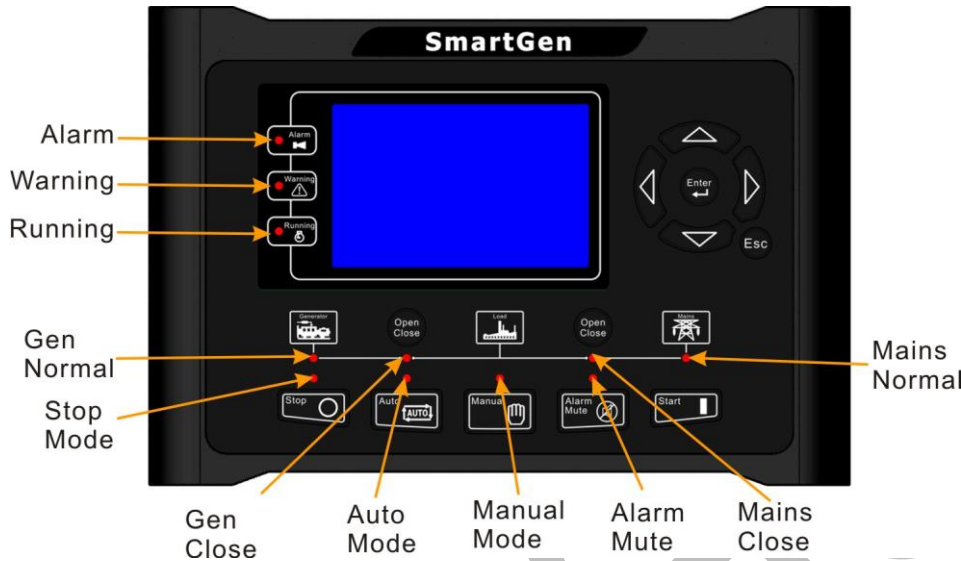

▲NOTE: Selected light indicators description:

Warning indicator and Alarm indicator:













Alarm Type	Warning Indicator	Alarm Indicator
Warning	Slow flashing	Slow flashing
Trip Alarm	Slow flashing	Slow flashing
Shutdown Alarm	Off	Fast flashing
Trip and Stop Alarm	Off	Fast flashing



Running indicator: illuminated from crank disconnect to ETS while off during other periods.

Gen normal indicator: It is illuminated when generator is normal; flashing when generator state is abnormal; off when there is no generator power.

Mains normal indicator: It is illuminated when mains is normal; flashing when mains state is abnormal; off when there is no mains power.

5.2 PUSHBUTTONS







	Stop	Stop running generator in Auto/Manual mode; Lamp test (press at least 3 seconds); Reset alarm in stop mode; During stopping process, press this button again to stop generator immediately.
	Start	Start genset in Manual mode.
	Manual Mode	Press this key and controller enters in Manual mode.
	Auto Mode	Press this key and controller enters in Auto mode.
	Mute/Reset Alarm	Alarming sound off; If there is trip alarm, pressing the button at least 3 seconds can reset this alarm.
	Gen Close/Open	Can control generator to switch on or off in Manual mode.
	Mains Close/Open	Can control mains to switch on or off in Manual mode.
	Up/Increase	1) Screen scroll; 2) Up cursor and increase value in setting menu.
	Down/Decrease	1) Screen scroll; 2) Down cursor and decrease value in setting menu.
	Left	1) Screen scroll; 2) Left move cursor in setting menu.
	Right	1) Screen scroll; 2) Right move cursor in setting menu.
	Set/Confirm	1. Select left/right viewing area; 2. Pressing and holding for more than 3 seconds enters parameter configuration menu; 3. In settings menu confirms the set value.
	Exit	1) Return to main menu; 2) Return to previous menu in setting menu.

 **NOTE:** Pressing  and  simultaneously will force generator to crank. Successful start will not be judged according to crank disconnect conditions, operator will have to crank the starter motor manually; when operator decides that the engine has fired, he/she should release the button and start output will be deactivated, safety on delay will start.

 **WARNING:** Default password is 00318, user can change it in case of others change the advanced parameters setting. Please clearly remember the password after changing. If you forget it, please contact Smartgen services and send all information in the controller page of “**ABOUT**” to us.

5.3 LCD DISPLAY

5.3.1 MAIN DISPLAY

Main screen is divided into left and right separate viewing areas, use  to select a viewing area; the selected area is marked with  in its upper left corner. Both viewing areas show pages; use   to scroll the pages and   to scroll the screen.

★**Status**, including as below,

Status of genset, ATS and mains

★**Engine**, including as below,

Speed, engine temperature, engine oil pressure, fuel level, configure sensor 1, configure sensor 2, battery voltage, charger voltage, accumulated run time, accumulated start times.

▲**NOTE:** If read parameters via CANBUS port using J1939, this page also includes: coolant pressure, coolant level, fuel temperature, fuel pressure, inlet temperature, exhaust temperature, turbo pressure, fuel consumption, total fuel consumption and so on. (Different engine with different parameters)

★**Generator**, including as below,

Phase voltage, Line voltage, frequency, phase sequence

★**Mains**, including as below

Phase voltage, Line voltage, frequency, phase sequence, mains current, active power, reactive power, apparent power, power factor, rate of change of frequency (ROCOF), vector shift (VS)

★**Load**, including as below,

Current, each phase and total active power (positive and negative), each phase and total reactive power (positive and negative), each phase and total apparent power, each phase and average power factor (positive and negative), accumulated energy (**kWh, kVarh, kVAh**), earth current, negative sequence current

▲**NOTE:** Power factor shows as following,

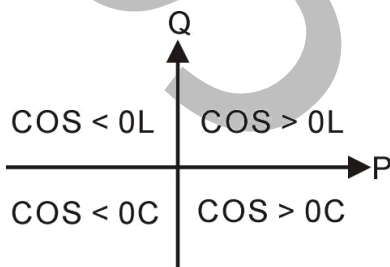

Remark:

P stands for active power

Q stands for reactive power

Power factor	Conditions	Active power	Reactive power	Remark
COS>0L	P>0,Q>0	Input	Input	Load is inductive resistance.
COS>0C	P>0,Q<0	Input	Output	Load is capacitance resistance.
COS<0L	P<0,Q>0	Output	Input	Load equal to one under excitation generator.
COS<0C	P<0,Q<0	Output	Output	Load equal to one over excitation generator.

▲Note:

1. Input active power, genset or mains supply electricity to load.
2. Output active power, load supply electricity to genset or mains.
3. Input reactive power, genset or mains send reactive power to load.
4. Output reactive power, load send reactive power to genset or mains.

★**SNYC**, including as below,

voltage difference, frequency difference, angle difference, active power percentage, target active power percentage, reactive power percentage, target reactive power percentage, GOV output percentage and AVR output percentage

★**Alarm:**

▲**NOTE:** For ECU alarms and shutdown alarms, if the alarm information is displayed, check engine according to it, otherwise, please check the manual of generator according to SPN alarm code.

★**Event log**

Make records about all start/stop events (shutdown alarm, trip and stop alarm, manual /auto start or stop) and the real time when alarm occurs.

★**Others**, including,

time and date, count down time for maintenance, input/output ports status.

★**About**, including,

Issue time of software and hardware version, product PD number

Example:

Status	Engine
Generator Status	Engine Speed
Manual Mode	1500r/min
Normal Running	Engine Temperature
Mains Status	85°C 185°F
Mains Abnormal	Engine Oil Pressure
Mains Overvolts	465kPa 67.4psi 4.65Bar
Switch Status	Fuel Level
Gen Closed	100%
1500r/min	27.6V
Normal Running	

Engine	Gen
Engine Speed 1500r/min	Voltage(L-N) 220V 220V 220V
Engine Temperature 85°C 185°F	Voltage(L-L) 380V 380V 380V
Engine Oil Pressure 465kPa 67.4psi	Frequency 50.00Hz
	Phase L1 – L2 – L3
1500r/min	27.6V Emergency Stop

5.3.2 USER MENU AND PARAMETERS SETTING MENU

Press key over 3s, entering into user manual.

★Parameter

After entering the correct password (factory default password is 00318) you can enter parameter settings screen.

★Language

Selectable Chinese, English and others (default: Espanol)

★Commissioning

On load, off load or custom commissioning can be chosen. Custom commissioning can configure on load or not during commissioning, when to commissioning and select the mode after commissioning (manual mode, auto mode and stop mode).

★Clear users' accumulation

Can clear total run time A and B, total electric energy A and B.

Parameter setting including as following,

★Mains settings

★Timer settings

★Engine settings

★Generator settings

★Load settings

★Switch settings

★Analog sensor settings

★Input port settings





★output port settings





★Module settings





★Scheduling and maintenance settings



★Synchronization settings







Example:





Return	>Start Delay	<p>Form1:</p> <p>Use   to scroll settings,  to enter settings (form2),  to exit settings menu.</p>
Mains	>Stop Delay	
Timers >	>Preheat Delay	
Engine	>Cranking Time	
Generator	>Crank Rest Time	
Load	>Safety On Time	
Switch	>Start Idle Time	
Temp. Sensor	>Warming Up Time	
OP Sensor	>Cooling Time	
Level Sensor	>Stop Idle Time	
Config Sensor 1	>ETS Hold Time	

Return	> Start Delay	<p>Form 2:</p> <p>Use   to scroll settings,  to enter settings (form3),  to return to previous menu. (form 1).</p>
Mains	> Stop Delay	
Timers >	> Preheat Delay	
Engine	> Cranking Time	
Generator	> Crank Rest Time	
Load	> Safety On Time	
Switch	> Start Idle Time	
Temp. Sensor	> Warming Up Time	
OP Sensor	> Cooling Time	
Level Sensor	> Stop Idle Time	
Config Sensor 1	> ETS Hold Time	

Return	> Start Delay	<p>Form 3:</p> <p>Use   to scroll settings,  to enter settings (form4),  to return to previous menu. (form 1).</p>
Mains	> Stop Delay	
Timers >	> Preheat Delay	
Engine	> Cranking Time	
Generator	> Crank Rest Time	
Load	> Safety On Time	
Switch	> Start Idle Time	
Temp. Sensor	> Warming Up Time	
OP Sensor	> Cooling Time	
Level Sensor	> Stop Idle Time	
Config Sensor 1	> ETS Hold Time	

<ul style="list-style-type: none"> > Start Delay > Stop Delay > Preheat Delay 	<p>00008</p>	<p>Form 4:</p> <p>Press  to enter settings (form 5),  to return to previous menu. (form 6).</p>
<ul style="list-style-type: none"> > Cranking Time > Crank Rest Time > Safty On Time > Start Idle Time > Warming Up Time > Cooling Time > Stop Idle Time > ETS Hold Time 		

<ul style="list-style-type: none"> > Start Delay > Stop Delay > Preheat Delay 	<p>00008</p>	<p>Form5:</p> <p>Press   to change cursor position,   are used for changing setting value,  confirm setting (form 4),  exit setting (form 4).</p>
<ul style="list-style-type: none"> > Cranking Time > Crank Rest Time > Safty On Time > Start Idle Time > Warming Up Time > Cooling Time > Stop Idle Time > ETS Hold Time 		

<ul style="list-style-type: none"> > Start Delay > Stop Delay > Preheat Delay 	<p>00008</p>	<p>Form 6:</p> <p>Use   to scroll settings.  to enter settings (form 4),  to return to previous menu. (form 2).</p>
<ul style="list-style-type: none"> > Cranking Time > Crank Rest Time > Safty On Time > Start Idle Time > Warming Up Time > Cooling Time > Stop Idle Time > ETS Hold Time 		

 **NOTE:** Long time pressing  can exit setting directly during setting.

5.4 AUTO START/STOP OPERATION

Press , its indicator lights, and controller enters **Auto** mode.

Starting Sequence,

The genset will start, synchronization, parallel and load sharing automatically according to the pre-set priority order.



- 1) When remote start (on-load) input is active or mains is abnormal, the controller enters into “start delay”
- 2) Count down of “start delay” is shown on “Status” screen.
- 3) When start delay is over, preheat relay outputs (if this be configured), “preheat start delay XX s” is shown on “Status” screen.
- 4) When preheat delay is over, fuel relay outputs 1s and then start relay output; if engine start fails during “cranking time”, the fuel relay and start relay stop outputs and enter into “crank rest time” and wait for next crank.
- 5) If generator start fails within setting crank times, controller will send “**Fail to start**” and the warning will be shown on LCD at the same time.
- 6) Whenever to start generator successfully, it will enter into “safety on time”. During this period, alarms of low oil pressure, high temperature, under speed, charge alt fails are inactive. As soon as this delay is over, generator will enter into “start idle delay” (if configured).
- 7) During “start idle delay”, alarms of under speed, under frequency, under voltage are inactive. As soon as this delay is over, generator will enter into “warming up delay”(if configured);
- 8) During single unit operation, when “Warming up Delay” is over, if generator state is normal, the generator state indicator will be illuminated; if voltage and frequency reach on-load demands, generator power supply indicator illuminates and normal running state begins; if voltage or frequency values are abnormal, the controller initiates alarm shutdown (corresponding alarm message will be displayed on LCD).
- 9) In case of running in parallel, when warming up delay is over:
 - a) If mains switch didn't close, then genset relay activate.
 - b) If mains switch already closed, the controller will adjust speed and voltage through GOV and AVR to synchronize gensets with mains; when synchronism requirements has been achieved, close signal will be initiated and the gen-set will be paralleled with the mains. Once they are parallel, the controller will control engine to share load.

▲Note: When started via “Remote Start (off Load)” input, same procedures as above but generator close relay deactivated, moreover, genset off load.

Stopping Sequence:

- 1) As soon as “Remote Start” deactivates and moreover, mains is normal, then “Stop Delay” begins.
- 2) When “Stop delay” is over, the controller will gradually transfer load to other generators, open breaker, and “Cooling Time” will begin. During cooling delay, if “Remote Start” signal recover active again, the controller will be parallel state again. When “Cooling Delay” is over, “Stop Idle Delay” starts;
- 3) Enter “Stop Idle Delay” (if it is configured), idle relay is energized.
- 4) “ETS delay” begins, ETS relay is energized while fuel relay is de-energized, and in addition, complete stop is detected automatically.
- 5) "Fail to Stop" delay begins and complete stop is detected automatically.
- 6) Enter “after stop” delay as soon as generator stops. Otherwise, controller will enter into “Failed to stop” delay and corresponding warning will be sent. (If gen-set stopped successfully after warning of “Failed to Stop”, it will enter “after stop delay” and remove alarm)
- 7) Enter “generator standby” as soon as “after stop time” is over.

5.5 MANUAL START/STOP OPERATION

- a) MANUAL START: Press , controller enters into Manual mode and its indicator lights. Press  to start generator, can automatically detect crank disconnect, and generator accelerates to high-speed running automatically. With high temperature, low oil pressure, over speed and abnormal voltage during generator running, controller can protect genset to stop quickly (please refer to No.4~9 of **Starting Sequence** for detail procedures).
- b) MANUAL STOP: Press  can stop the running generators. (Please refer to No.2~7 of **Stopping Sequence** for detail procedures).

▲ NOTE: In “manual mode”, the procedures of ATS please refer to **Switch Control Procedure** of generator in this manual.

5.6 SWITCH CONTROL PROCEDURES

5.6.1 MANUAL TRANSFER PROCEDURES

When controller is in **Manual** mode, the switch control procedures will start through manual transfer. Users can control the loading transfer of ATS via pressing  button to switch on or off.

Generator Closing Operation: During genset normal running, press  when the generator voltage and frequency reach load requirement.

- a) If mains switch didn't close, then genset close relay activate.
- b) If mains switch already closed, the controller will adjust speed and voltage through GOV and AVR to synchronize genset with mains; when synchronism requirement has been achieved, breaker close signal will be initiated and the genset will be paralleled with the mains.

Generator Opening operation: Press ,

- 1) If mains switch didn't close, the controller sends open breaker signal.
- 2) If mains switch already closed, first of all, the controller will transfer load to mains, and only then send an opening signal.

Mains Closing Operation: During genset normal running, press :

- a) If generator switch didn't close, then mains close relay activate.
- b) If generator switch already closed, the controller will adjust speed and voltage through GOV and AVR to synchronize genset with mains; when synchronism requirement has been achieved, breaker close signal will be initiated.

Mains Opening operation: Press ,

- 1) If generator switch didn't close, the controller sends open breaker signal.
- 2) If generator switch already closed, first of all, the controller will transfer load to generators, and only then send an opening signal.

5.6.2 AUTOMATIC CONTROL PROCEDURE

When controller is in auto mode, the switch control procedure will start through automatic control procedure.

 **Note:** The auxiliary close input port must be configured and make sure the connection is correct.

6 PROTECTIONS

6.1 WARNING ALARMS

Warnings are not shutdown alarms and do not affect the operation of the genset.

Warning alarms types are as follows:

No.	Type	Description
1	Over Speed	When controller detects the speed is higher than the set value, it will send warning signal.
2	Under Speed	When controller detects the speed is lower than the set value, it will send warning signal.
3	Loss of Speed Signal	When controller detects the speed is 0 and the action select "Warn", it will send warning signal.
4	Over Frequency	When controller detects the generator frequency is higher than the set value, it will send warning signal.
5	Under Frequency	When controller detects the generator frequency is lower than the set value, it will send warning signal.
6	Over Voltage	When controller detects the generator voltage is higher than the set value, it will send warning signal.
7	Under Voltage	When controller detects the generator voltage is lower than the set value, it will send warning signal.
8	Over Current	When controller detects the generator current is higher than the set value and the action select "Warn", it will send warning signal.
9	Fail to Stop	When generator not stops after the "stop delay" is over, it will send warning signal.
10	Charge Alt Fail	When controller detects the charger voltage is lower than the set value, it will send warning signal.
11	Battery Over Voltage	When controller detects the battery voltage is higher than the set value, it will send warning signal.
12	Battery Under Voltage	When controller detects the battery voltage is lower than the set value, it will send warning signal.
13	Maintenance Due	When count down time is 0 and the action select "Warn", it will send warning signal.
14	Reverse Power	When controller detects the reverse power value (power is negative) is lower than the set value and the action select "Warn", it will send warning signal.
15	Over Power	When controller detects the power value (power is positive) is higher than the set value and the action select "Warn", it will send warning signal.
16	ECU Warn	When controller gets the warning signal from engine via J1939, it will send warning signal.
17	Gen Loss of Phase	When controller detects the generator loss phase, it will send warning signal.
18	Gen Phase Sequence Wrong	When controller detects the reverse phase, it will send warning signal.

No.	Type	Description
19	Gen Switch Fail Warn	When controller detects the generator switch on and off failure or the status of generator input port is not configured, it will send warning signal.
20	Mains Switch Fail Warn	When controller detects the mains switch on and off failure or the status of mains input port is not configured, it will send warning signal.
21	Temp. Sensor Open	When controller detects the sensor is open circuit, and the action select "Warn", it will send warning signal.
22	High Temp. Warn	When controller detects the temperature is higher than the set value, it will send warning signal.
23	Low Temp. Warn	When controller detects the temperature is lower than the set value, it will send warning signal.
24	Pressure Sensor Open	When controller detects the sensor is open circuit, and the action select "Warn", it will send warning signal.
25	Low OP Warn	When controller detects the oil pressure is lower than the set value, it will send warning signal.
26	Level Sensor Open	When controller detects the sensor is open circuit, and the action select "warn", it will send warning signal.
27	Low Level Warn	When controller detects the fuel lever is lower than the set value, it will send warning signal.
28	Flexible Sensor 1 Open	When controller detects the sensor is open circuit, and the action select "Warn", it will send warning signal.
29	Flexible Sensor 1 High	When controller detects the sensor value is higher than the maximum set value, it will send warning signal.
30	Flexible Sensor 1 Low	When controller detects the sensor value is lower than the minimum set value, it will send warning signal.
31	Flexible Sensor 2 Open	When controller detects the sensor is open circuit, and the action select "Warn", it will send warning signal.
32	Flexible Sensor 2 High	When controller detects the sensor value is higher than the maximum set value, it will send warning signal.
33	Flexible Sensor 2 Low	When controller detects the sensor value is lower than the minimum set value, it will send warning signal.
34	Digital Input Warn	When digital input port is set as "User Defined" and the action select "Warn", controller sends corresponding warning signal when the alarm is active.
35	Earth Fault	When controller detects earth current is greater than set value, and the action select "Warn", it will send warning signal.
36	Negative Sequence Current	When the controller detects that negative phase current has exceeded the set value and the action select "Warn", it will send warning signal.
37	Fail to Sync	The controller does not detect synchronization signal within the pre-set synchronization time, it will send warning signal.
38	Loss of Excitation	When controller detects negative reactive power is greater than set value and the action select "Warn", it will send warning signal.

6.2 SHUTDOWN ALARMS

When controller detects shutdown alarm, it will send signal to open breaker and shuts down generator.

Shutdown alarms as following:

No.	Type	Description
1	Emergency Stop	When controller detects emergency stop signal, it will send a shutdown signal.
2	Over Speed	When controller detects the generator speed is higher than the set value, it will send a shutdown signal.
3	Under Speed	When controller detects the generator speed is lower than the set value, it will send a shutdown signal.
4	Loss of Speed Signal	When controller detects the generator speed is 0 and the action select "Shutdown", it will send a shutdown signal.
5	Over Frequency	When controller detects the generator frequency is higher than the set value, it will send a shutdown signal.
6	Under Frequency	When controller detects the generator frequency is lower than the set value, it will send a shutdown signal.
7	Over Voltage	When controller detects the generator voltage is higher than the set value, it will send a shutdown signal.
8	Under Voltage	When controller detects the generator voltage is lower than the set value, it will send a shutdown signal.
9	Fail To Start	If genset start fail within setting of start times, controller will send a shutdown signal.
10	Over Current	When controller detects the current is higher than the set value and the action select "Shutdown", it will send a shutdown signal.
11	Maintenance Due	When count down time is 0 and the action select "Shutdown", it will send a shutdown signal.
12	ECU Shutdown	When controller gets the shutdown signal from engine via J1939, it will send a shutdown signal.
13	ECU Com Fail Shutdown	When controller not gets data from engine via J1939, it will send a shutdown signal.
14	Reverse Power Shutdown	When controller detects the reverse power value (power is negative) is lower than the set value and the action select "Shutdown", it will send a shutdown signal.
15	Over Power Shutdown	When controller detects the power value (power is positive) is higher than the set value and the action select "Shutdown", it will send a shutdown signal.
16	Temp. Sensor Open	When controller detects the sensor is open circuit, and the action select "Shutdown", it will send a shutdown signal.
17	High Temp. Shutdown	When controller detects the temperature is higher than the set value, it will send a shutdown signal.
18	Pressure Sensor Open	When controller detects the sensor is open circuit, and the action select "Shutdown", it will send shutdown signal.
19	Low OP Shutdown	When controller detects the oil pressure is lower than the set value, it will send a shutdown signal.

No.	Type	Description
20	Level Sensor Open	When controller detects the sensor is open circuit, and the action select "Shutdown", it will send a shutdown signal.
21	Flexible Sensor 1 Open	When controller detects the sensor is open circuit, and the action select "Shutdown", it will send a shutdown signal.
22	Flexible Sensor 1 High	When controller detects the sensor value is higher than the maximum set value, it will send a shutdown signal.
23	Flexible Sensor 1 Low	When controller detects the sensor value is lower than the minimum set value, it will send a shutdown signal.
24	Flexible Sensor 2 Open	When controller detects the sensor is open circuit, and the action select "Shutdown", it will send a shutdown signal.
25	Flexible Sensor 2 High	When controller detects the sensor value is higher than the maximum set value, it will send a shutdown signal.
26	Flexible Sensor 2 Low	When controller detects the sensor value is lower than the minimum set value, it will send a shutdown signal.
27	Digital Input Shutdown	When digital input port is set as "User Defined" and the action select "Shutdown", controller sends corresponding shutdown signal when the alarm is active.
28	Earth Fault	When controller detects earth current is greater than the set value, and the action select "Shutdown", it will send a "Shutdown" alarm signal.
29	Negative Sequence Current	When the controller detects that negative phase current has exceeded the set value and the action select "Shutdown", it will send shutdown signal.
30	Loss of Excitation	When controller detects negative reactive power is greater than set value and the action select "Shutdown", it will send shutdown signal.

6.3 TRIP AND STOP ALARMS

When the controller detects trip and stop signal, it immediately disconnects generator breaker, which leads to unloading and then generator is cooling down and stopped.

No.	Type	Description
1	Over Current	When controller detects the generator current is higher than the set value and the action select "trip and stop", it will send a "trip and stop" signal.
2	Maintenance Due	When count down time is 0 and the action select "trip and stop", it will send a "trip and stop" signal.
3	Reverse Power	When controller detects the generator reverse power value (power is negative) is lower than the set value and the action select "trip and stop", it will send a "trip and stop" signal.
4	Over Power	When controller detects the power value (power is positive) is higher than the set value and the action select "trip and stop", it will send a "trip and stop" signal.
5	Digital Input Ports	When digital input port is set as "User Defined" and the action select "trip and stop", controller sends corresponding "trip and stop" signal when the alarm is active.
6	Earth Fault	When controller detects earth current is greater than the set value, and the action select "trip and stop", it will send a "trip and stop" alarm signal.
7	Negative Sequence Current	When the controller detects that negative phase current has exceeded the set value and the action select "trip and stop", it will send "trip and stop" signal.
8	Loss of Excitation	When controller detects negative reactive power is greater than the set value and the action select "trip and stop", it will send a "trip and stop" signal.
9	Mains Over Freq	When controller detects the mains frequency is higher than the set value, it will send a "trip and stop" signal.
10	Mains Under Freq	When controller detects the mains frequency is lower than the set value, it will send a "trip and stop" signal.
11	Mains Over Voltage	When controller detects the mains voltage is higher than the set value, it will send a "trip and stop" signal.
12	Mains Under Voltage	When controller detects the mains voltage is lower than the set value, it will send a "trip and stop" signal.
13	Mains ROCOF	When controller detects the ROCOF (rate of change of frequency) is higher than the set value, it will send a "trip and stop" signal.
14	Mains Vector Shift	When controller detects the vector shift value is higher than the set value, it will send a "trip and stop" signal.

6.4 TRIP ALARM

When controller detects trip alarm, it will open breaker immediately, but genset not stop.

Trip alarm as following,

No.	Type	Description
1	Over Current	When controller detects the current is higher than the set value and the action select "trip", it will send a "trip" signal.
2	Reverse Power	When controller detects the reverse power value (power is negative) is lower than the set value and the action select "trip", it will send a "trip" signal.
3	Over Power	When controller detects the power value (power is positive) is higher than the set value and the action select "trip", it will send a "trip" signal.
4	Digital Input Port	When digital input port is set as "User Defined" and the action select "trip", controller sends corresponding "trip" signal when the alarm is active.
5	Earth Fault	When controller detects earth current is greater than the set value and the action select "trip", it will send a "trip" alarm signal.
6	Negative Sequence Current	When the controller detects that negative phase current has exceeded the set value and the action select "trip", it will send a "trip" alarm signal.
7	Loss of Excitation	When controller detects negative reactive power is greater than the set value and the action select "trip", it will send a "trip" signal.

7 WIRING CONNECTION

HGM9520 controller's rear as following:

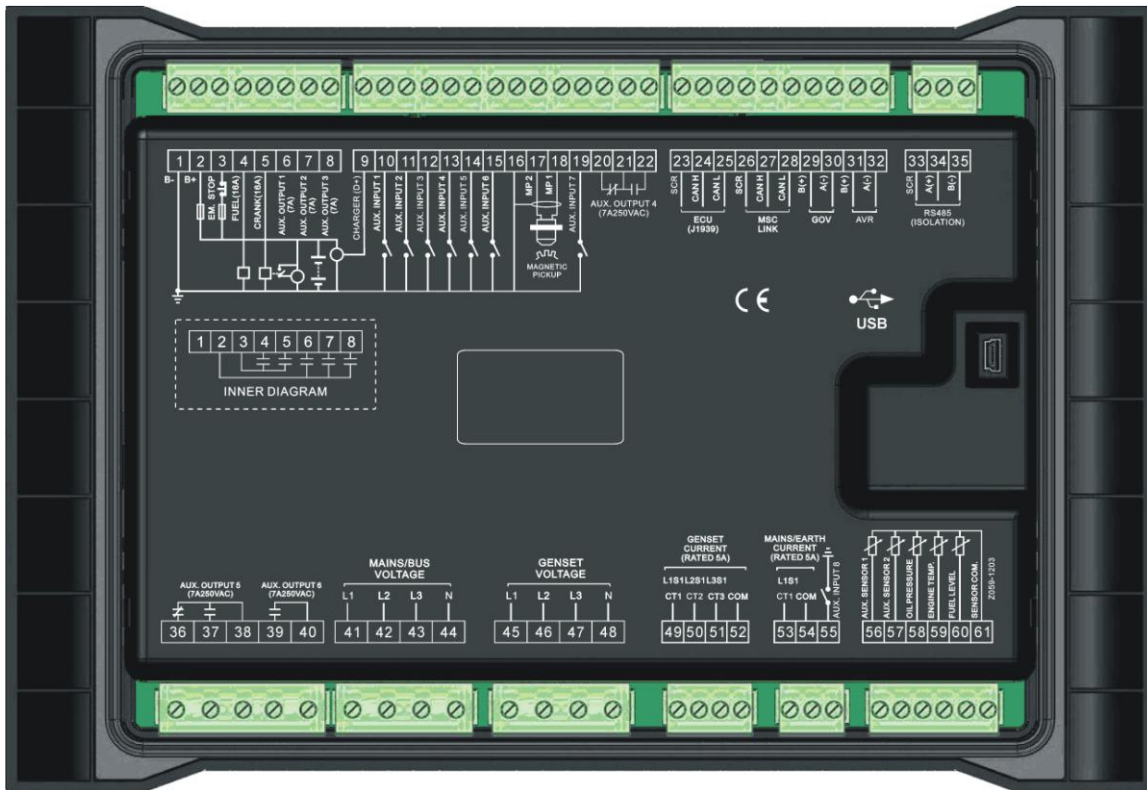

Description of terminal connection:

NO.	Functions	Cable Size	Remark	
1	DC input B-	2.5mm ²	Connected with negative of starter battery.	
2	DC input B+	2.5mm ²	Connected with positive of starter battery. If wire length is over 30m, better to double wires in parallel. Max. 20A fuse is recommended.	
3	Emergency stop	2.5mm ²	Connected with B+ via emergency stop button.	
4	Fuel relay	1.5mm ²	B+ is supplied by 3 point, rated 16A.	
5	Start Relay	1.5mm ²	B+ is supplied by 3 point, rated 16A.	Connected to starter coil
6	Aux. output 1	1.5mm ²	B+ is supplied by 2 point, rated 7A	Details see form 2
7	Aux. output 2	1.5mm ²	B+ is supplied by 2 point, rated 7A	
8	Aux. output 3	1.5mm ²	B+ is supplied by 2 point, rated 7A	
9	Charger (D+)	1.0mm ²	Connected with charger's D+ (WL) terminals. Be hanging in the air If there is no this terminal.	
10	Aux. input 1	1.0mm ²	Ground connected is active (B-).	Details see form 3
11	Aux. input 2	1.0mm ²	Ground connected is active (B-).	
12	Aux. input 3	1.0mm ²	Ground connected is active (B-).	
13	Aux. input 4	1.0mm ²	Ground connected is active (B-).	
14	Aux. input 5	1.0mm ²	Ground connected is active (B-).	
15	Aux. input 6	1.0mm ²	Ground connected is active (B-).	
16	Magnetic Pickup Shielding	0.5mm ²	Connected with Speed sensor, shielding line is recommended. (B-) has already connected with speed sensor 2.	
17	MP2			

HGM9520 Genset Parallel (With Mains) Unit

NO.	Functions	Cable Size	Remark	
18	MP1			
19	Aux. input 7	1.0mm ²	Ground connected is active (B-).	Details see form 3
20	Aux. output 4	1.5mm ²	Normally close outputs, rated 7A.	Details see form 2
21			Public points of relay	
22			Normally open outputs, rated 7A.	
23	ECU CAN COM(GND)	/	Impedance-120Ω shielding wire is recommended, its single-end earthed.	
24	ECU CAN H	0.5mm ²		
25	ECU CAN L	0.5mm ²		
26	MSC CAN COM(GND)	/	These are reserved terminals, do not connect to wire.	
27	MSC CAN H	/		
28	MSC CAN L	/		
29	GOV B(+)	0.5mm ²	Shielding line is recommended. Shielding layer connect to earth at GOV end.	
30	GOV A(-)	0.5mm ²		
31	AVR B(+)	0.5mm ²	Shielding line is recommended. Shielding layer connect to earth at AVR end.	
32	AVR A(-)	0.5mm ²		
33	RS485 COM(GND)	/	Impedance-120Ω shielding wire is recommended, its single-end earthed.	
34	RS485-	0.5mm ²		
35	RS485+	0.5mm ²		
36	Aux. output 5	2.5mm ²	Normally close outputs, rated 7A.	Details see form 2
37		2.5mm ²	Normally open outputs, rated 7A.	
38		2.5mm ²	Public points of relay	
39	Aux. output 6	2.5mm ²	Normally open outputs, rated 7A.	
40		2.5mm ²	Public points of relay	
41	Mains A-phase voltage sensing input	1.0mm ²	Connected to A-phase of mains (2A fuse is recommended).	
42	Mains B-phase voltage sensing input	1.0mm ²	Connected to B-phase of mains (2A fuse is recommended).	
43	Mains C-phase voltage sensing input	1.0mm ²	Connected to C-phase of mains (2A fuse is recommended).	
44	Mains N-wire input	1.0mm ²	Connected to N-wire of mains.	
45	Genset A-phase voltage sensing input	1.0mm ²	Connected to A-phase of genset (2A fuse is recommended).	
46	Genset B-phase voltage sensing input	1.0mm ²	Connected to B-phase of genset (2A fuse is recommended).	
47	Genset C-phase voltage sensing input	1.0mm ²	Connected to C-phase of genset (2A fuse is recommended).	
48	Genset N-wire input	1.0mm ²	Connected to N-wire of genset.	
49	CT A-phase sensing input	1.5mm ²	Externally connected to secondary coil of current transformer (rated 5A).	
50	CT B-phase sensing input	1.5mm ²	Externally connected to secondary coil of current transformer (rated 5A).	
51	CT C-phase sensing input	1.5mm ²	Externally connected to secondary coil of current transformer (rated 5A).	
52	CT COM	1.5mm ²	See following section entitled <i>Installation</i> .	
53	Mains Current	1.5mm ²	Outside connected to secondary coil of current transformer(rated 5A).	
54		1.5mm ²		

NO.	Functions	Cable Size	Remark	
55	Aux. input 8	1.0mm ²	Ground connected is active (B-).	Details see form 3
56	Aux. sensor 1	1.0mm ²	Connect to temperature, oil pressure or fuel level sensors.	Details see form 4
57	Aux. sensor 2	1.0mm ²		
58	Oil pressure	1.0mm ²		
59	Engine Temp.	1.0mm ²		
60	Fuel level	1.0mm ²	Connect to fuel level sensor.	
61	Sensor COM	/	Public terminal of sensor, (B-) has already connected internal.	

▲ **NOTE:** USB port in controller rear panel is configurable parameter ports, user can directly program controller via PC.

▲ **NOTE:** Please refer to the [Modules Comparison](#) in this manual for more products' functions.

8 SCOPES AND DEFINITIONS OF PROGRAMMABLE PARAMETERS

8.1 CONTENTS AND SCOPES OF PARAMETERS

Form 1

No.	Items	Parameters	Defaults	Description
Mains Setting				
Mains Setting-Basic				
1	AC System	(0~3)	0	0: 3P4W; 1: 3P3W; 2: 2P3W; 3: 1P2W.
2	Rated Voltage	(30~30000)V	230	Standard for checking mains over/under voltage. (It is primary voltage when using voltage transformer; it is line voltage when AC system is 3P3W while it is phase voltage when using other AC system).
3	Rated Frequency	(10.0~75.0)Hz	50.0	Standard for checking mains over/under frequency.
4	Normal Time	(0~3600)s	10	The delay from mains abnormal to normal.
5	Abnormal Time	(0~3600)s	5	The delay from mains normal to abnormal.
6	Volt. Trans.(PT)	(0~1)	0	0: Disable ; 1: Enable
7	Over Voltage	(0~200)%	120%	Setting value is mains rated voltage's percentage, and return value (default: 116%) and delay value (default: 5s) can be set.
8	Under Voltage	(0~200)%	80%	Setting value is mains rated voltage's percentage, and return value (default: 84%) and delay value (default: 5s) can be set.
9	Over Frequency	(0~200)%	114%	Setting value is mains rated frequency's percentage, return value (default: 110%) and delay value (default: 5s) can be set.
10	Under Frequency	(0~200)%	90%	Setting value is mains rated frequency's percentage, return value (default: 94%) and delay value (default: 5s) can be set.
11	Current Trans.	(5-6000)/5	500	The ratio of external CT
12	Full Load Active Power	(1-60000)kW	345	Mains' active power, standard of load distribute.
13	Full Load Reactive Power	(1-60000)kVar	258	Mains' reactive power, standard of load distribute.
14	Output Power Limit Alarm	(0-60000)kW	0	Alarm action can be set (default: warning); Alarm when output power greater than the set value.

No.	Items	Parameters	Defaults	Description
Mains Setting-Sync				
1	Alarm Action	(0-1)	0	0: Trip and Stop; 1: Auxiliary mains fail
2	Over Voltage	(0-200)%	105%	Setting value is mains rated voltage's percentage, action (default: trip and stop) and delay value (default: 0.1s) can be set.
3	Under Voltage	(0-200)%	95%	
4	Over Frequency	(0-200)%	105%	
5	Under Frequency	(0-200)%	95%	Setting value is mains rated frequency's percentage, action (default: trip and stop) and delay value (default: 0.1s) can be set.
6	ROCOF	(0-1.00)Hz/s	0.20	Setting value is rate of change of frequency (ROCOF), action (default: trip and stop) and delay value (default: 0.1s) can be set.
7	VECTOR SHIFT	(0-20.0)°	6.0	Setting value is the change value of voltage waveform, action (default: trip and stop) and delay value (default: 0.1s) can be set.
Timer Setting				
1	Start Delay	(0~3600)s	5	Time from mains abnormal or remote start signal is active to start genset.
2	Stop Delay	(0~3600)s	30	Time from mains normal or remote start signal is deactivated to genset stop.
3	Preheat Delay	(0~3600)s	0	Time of pre-powering heat plug before starter is powered up.
4	Cranking Time	(3~60)s	8	Time of starter power up
5	Crank Rest Time	(3~60)s	10	The waiting time before second power up when engine start fail.
6	Safety On Delay	(0~3600)s	10	Alarms for low oil pressure, high temperature, under speed, under frequency/voltage, charge alt fail are inactive.
7	Start Idle Time	(0~3600)s	10	Idle running time of genset when starting.
8	Warming Up Time	(0~3600)s	30	Warming time between genset high speed running and switch on.
9	Cooling Time	(0~3600)s	60	Radiating time before genset stop, after it unloads.
10	Stop Idle Time	(0~3600)s	10	Idle running time when genset stop.
11	ETS Solenoid Hold	(0~3600)s	20	Stop electromagnet's power on time when genset is stopping.
12	Fail to Stop Delay	(0~3600)s	0	Time between end of genset idle delay and stopped when "ETS Solenoid Hold" is set as 0; Time between end of ETS hold delay and stopped when "ETS Solenoid Hold" is not 0.
13	After Stop	(0~3600)s	0	Time between genset stopped and

No.	Items	Parameters	Defaults	Description
	Time			standby
Engine Setting				
1	Engine Type	(0~39)	0	Default: Conventional genset (not J1939) When connected to J1939 engine, choose the corresponding type.
2	Flywheel Teeth	(10~300)	118	Tooth number of the engine, for judging of starter disconnect conditions and inspecting of engine speed. See following section entitled <i>Installation</i> .
3	Rated Speed	(0~6000)r/min	1500	Offer standard to judge over/under/loading speed.
4	Speed on Load	(0~100)%	90%	Setting value is percentage of rated speed. Controller detects when it is ready to load. It won't enter into normal running when speed is under loading speed.
5	Loss of Speed Signal	(0~3600)s	5	Time from detecting speed is 0 to confirm the action.
6	Loss of Speed Action	(0~1)	0	0:Warn; 1:Shutdown
7	Over Speed Shutdown	(0~200)%	114%	Setting value is percentage of rated speed and delay value (default: 2s) also can be set.
8	Under Speed Shutdown	(0~200)%	80%	Setting value is percentage of rated speed and delay value (default: 3s) also can be set.
9	Over Speed Warn	(0~200)%	110%	Setting value is percentage of rated speed and delay value (default: 5s) and return value (default: 108%) also can be set.
10	Under Speed Warn	(0~200)%	86%	Setting value is percentage of rated speed and delay value (default: 5s) and return value (default: 90%) also can be set.
11	Battery Rated Voltage	(0~60.0)V	24.0	Standard for detecting over/under voltage of battery.
12	Battery Over Volts	(0~200)%	120%	Setting value is percentage of rated voltage of battery. Delay value (default: 60s) & return value (default: 115%) also can be set.
13	Battery Under Volts	(0~200)%	85%	Setting value is percentage of rated voltage of battery. Delay value (default: 60s) & return value (default: 90%) also can be set.
14	Charge Alt Fail	(0~60.0)V	8.0	In normal running, when charger D+(WL) voltage under this value, charge failure alarms. Delay value (default: 10s) & return value (default:

No.	Items	Parameters	Defaults	Description
				10.0V) also can be set.
15	Start Attempts	(1~10)times	3	Maximum crank times of crank attempts. When reach this number, controller will send start failure signal.
16	Crank Disconnect	(0~6)	2	See form 5 There are 3 conditions of disconnecting starter with engine. Each condition can be used alone and simultaneously to separating the start motor and genset as soon as possible.
17	Disconnect Generator Freq	(0~200)%	30%	Setting value is percentage of generator rated frequency. When generator frequency higher than the set value, starter will be disconnected.
18	Disconnect Engine Speed	(0~200)%	30%	Setting value is percentage of rated speed. When generator speed higher than the set value, starter will be disconnected.
19	Disconnect Oil Pressure	(0~1000)kPa	200	When generator oil pressure higher than the set value, starter will be disconnected.
Generator Setting				
1	AC System	(0~3)	0	0: 3P4W; 1: 3P3W; 2: 2P3W; 3: 1P2W.
2	Poles	(2~32)	4	Number of generator poles, used for calculating starter rotate speed when without speed sensor.
3	Rated Voltage	(30~30000)V	230	To offer standards for detecting of generator' over/under voltage and loading voltage. (It is primary voltage when using voltage transformer; it is line voltage when AC system is 3P3W while it is phase voltage when using other AC system).
4	Loading Voltage	(0~200)%	90%	Setting value is percentage of generator rated voltage. Detect when controller prepare loading. When generator voltage under load voltage, won't enter into normally running.
5	Rated Frequency	(10.0~75.0) Hz	50.0	To offer standards for detecting of over/under/load frequency.
6	Loading Frequency	(0~200)%	90%	Setting value is percentage of generator rated frequency. Detect when controller prepare loading. When generator frequency under load frequency, it won't enter into normal running.
7	Volt. Trans.(PT)	(0~1)	0	0: Disable; 1:Enable
8	Over Volt.	(0~200)%	120%	Setting value is percentage of generator

No.	Items	Parameters	Defaults	Description
	Shutdown			rated voltage. Delay value (default: 3s) also can be set.
9	Under Volt. Shutdown	(0~200)%	80%	
10	Over Freq. Shutdown	(0~200)%	114%	Setting value is percentage of generator rated frequency. Delay value (default: 2s) also can be set.
11	Under Freq. Shutdown	(0~200)%	80%	Setting value is percentage of generator rated frequency. Delay value (default: 3s) also can be set.
12	Over Volt. Warn	(0~200)%	110%	Setting value is percentage of generator rated voltage. Delay value (default: 5s) and return value (default: 108%) also can be set.
13	Under Volt. Warn	(0~200)%	84%	Setting value is percentage of generator rated voltage. Delay value (default: 5s) and return value (default: 86%) also can be set.
14	Over Freq. Warn	(0~200)%	110%	Setting value is percentage of generator rated frequency. Delay value (default: 5s) and return value (default: 108%) also can be set.
15	Under Freq. Warn	(0~200)%	84%	Setting value is percentage of generator rated frequency. Delay value (default: 5s) and return value (default: 86%) also can be set.
16	Loss of Phase	(0~1)	1	0: Disable 1: Enable
17	Phase Sequence Wrong	(0~1)	1	
Load Setting				
1	Current Trans.	(5~6000)/5	500	The ratio of external CT
2	Full Current Rating	(5~6000)A	500	Generator's rated current, standard for load current.
3	Full kW rating	(1~20000)kW	276	Generator's full load active power, standard for load power.
4	Full kVar rating	(1~20000)kVar	210	Generator's full load reactive power, standard for load power.
5	Over Current	(0~200)%	120%	Setting value is percentage of generator rated full load current. Delay value can be set as Definite Time or Inverse Definite Minimum Time (IDMT) and full setting details are given in the section follow form 1.
6	Over Power	(0-200)%	110%	Setting value is percentage of generator rated full load active power. Delay value (default: 30s) and action (default: trip and stop) also can be set.
7	Reverse	(0-200)%	10%	Setting value is percentage of generator

No.	Items	Parameters	Defaults	Description
	Power			rated full load active power. Delay value (default: 10s) and action (default: trip and stop) also can be set.
8	Earth Fault	(0~1)	0	0: Disable 1: Enable
9	Negative Sequence Current	(0~1)	0	0: Disable 1: Enable
10	Loss of Excitation	(0-200)%	20%	Setting value is percentage of generator rated full load reactive power. Delay value (default: 5s) and action (default: trip) also can be set.
Switch Setting				
1	Close Time	(0~20.0)s	5.0	Pulse width of switch on. When it is 0, means output constantly.
2	Open Time	(0~20.0)s	3.0	Pulse width of switch off.
Module Setting				
1	Power on Mode	(0~2)	0	0: Stop mode 1: Manual mode 2: Auto mode
2	Module Address	(1~254)	1	Controller's address during remote sensing.
3	Stop Bits	(0~1)	0	0: 2 stop bits; 1: 1 stop bit
4	Language	(0~2)	0	0: Simplified Chinese 1: English 2: Others
5	Password	(0~65535)	00318	For entering advanced parameters setting.
Scheduling And Maintenance Setting				
1	Scheduled Run	(0~1)	0	0: Disable; 1: Enable
2	Scheduled Not Run	(0~1)	0	0: Disable; 1: Enable
3	Maintenance	(0~1)	0	0: Disable; 1: Enable
Analog Sensors Setting				
Temperature Sensor				
1	Curve Type	(0~15)	7	SGX See form 4.
2	Open Circuit Action	(0~2)	0	0: Warn; 1: Shutdown; 2: No action
3	High Temp. Shutdown	(0~300)°C	98	Shutdown when sensor temperature higher than this value. Detect only when safety delay is over. The delay value (default: 3s) also can be set.
4	High Temp. Warn	(0~300) °C	95	Warn when sensor temperature higher than this value. Detect only when safety delay is over. The delay value (default: 5s) and return value (default: 93) also can be set.
5	Low Temp. Warn	(0~1)	0	0: Disable; 1: Enable
Oil Pressure Sensor				

No.	Items	Parameters	Defaults	Description
1	Curve Type	(0~15)	7	SGX See form 4.
2	Open Circuit Action	(0~2)	0	0: Warn 1: Shutdown 2: No action
3	Low OP Shutdown	(0~1000)kPa	103	Shutdown when oil pressure higher than this value. Detect only when safety delay is over. The delay value (default: 3s) also can be set.
4	Low OP Warn	(0~1000)kPa	124	Warn when oil pressure higher than this value. Detect only when safety delay is over. The delay value (default: 5s) and return value (default: 138) also can be set.
Liquid Level Sensor				
1	Curve Type	(0~15)	4	SGH See form 4
2	Open Circuit Action	(0~2)	0	0:Warn; 1:Shutdown; 2:No action
3	Low Level Warn	(0~300)%	10	Warn when level lower than this value. It is detecting all the time. The delay value (default: 5s) and return value (default: 15%) also can be set.
Flexible Sensor 1				
1	Flexible Sensor 1 Setting	(0~1)	0	0: Disable 1: Enable; (can be set as temperature/pressure/liquid lever sensor).
Flexible Sensor 2				
1	Flexible Sensor 2 Setting	(0~1)	0	0: Disable; 1: Enable; (can be set as temperature/pressure/liquid lever sensor).
Flexible Input Ports				
Flexible Input Port 1				
1	Contents Setting	(0~50)	31	Remote Start On Load Demand. See form 3
2	Active Type	(0~1)	0	0: Closed to active 1: Open to active
Flexible Input Port 2				
1	Contents Setting	(0~50)	27	Low oil pressure shutdown See form 3
2	Active Type	(0~1)	0	0: Closed to active 1: Open to active
Flexible Input Port 3				
1	Contents Setting	(0~50)	26	High temperature shutdown See form 3
2	Active Type	(0~1)	0	0: Closed to active 1: Open to active
Flexible Input Port 4				
1	Contents Setting	(0~50)	13	Generator Closed Auxiliary. See form 3
2	Active Type	(0~1)	0	0: Closed to active 1: Open to active
Flexible Input Port 5				
1	Contents Setting	(0~50)	0	User defined. See form 3

HGM9520 Genset Parallel (With Mains) Unit

No.	Items	Parameters	Defaults	Description
2	Active Type	(0~1)	0	0: Closed to active 1: Open to active
3	Arming	(0~3)	3	0: From safety on 1: From starting 2: Always 3:Never
4	Active Actions	(0~4)	4	0: Warn; 1: Shutdown; 2:Trip and stop 3:Trip 4: Indication
5	Active Delay	(0~20.0)s	2.0	Time from detecting active to confirm
6	Description			LCD display detailed contents when the input is active.
Flexible Input Port 6				
1	Contents Setting	(0~50)	44	Reserved. See form 3
2	Active Type	(0~1)	0	0: Closed to active 1: Open to active
Flexible Input Port 7				
1	Contents Setting	(0~50)	0	User defined. See form 3
2	Active Type	(0~1)	0	0: Closed to active 1: Open to active
3	Arming	(0~3)	3	0: From safety on 1: From starting 2: Always 3:Never
4	Active Actions	(0~4)	4	0: Warn; 1: Shutdown; 2:Trip and stop 3:Trip 4: Indication
5	Active Delay	(0~20.0)s	2.0	Time from detecting active to confirm
6	Description			LCD display detailed contents when the input is active.
Flexible Input Port 8				
1	Contents Setting	(0~50)	15	Mains Closed Auxiliary. See form 3
2	Active Type	(0~1)	0	0: Closed to active 1: Open to active
Flexible Output Ports				
Flexible Output Port 1				
1	Contents Setting	(0~239)	44	Generator OK. See Form 2
2	Active Type	(0~1)	0	0:Normally open; 1:Normally close
Flexible Output Port 2				
1	Contents Setting	(0~239)	48	Common Alarm. See Form 2
2	Active Type	(0~1)	0	0:Normally open; 1:Normally close
Flexible Output Port 3				
1	Contents Setting	(0~239)	38	Energize to Stop. See form 2
2	Active Type	(0~1)	0	0:Normally open; 1:Normally close
Flexible Output Port 4				
1	Contents Setting	(0~239)	35	Idle Control. See form 2
2	Active Type	(0~1)	0	0:Normally open; 1:Normally close
Flexible Output Port 5				
1	Contents Setting	(0~239)	30	Open Gen Output. See form 2
2	Active Type	(0~1)	0	0:Normally open; 1:Normally close

HGM9520 Genset Parallel (With Mains) Unit

No.	Items	Parameters	Defaults	Description
Flexible Output Port 6				
1	Contents Setting	(0~239)	29	Close Gen Output. See form 2
2	Active Type	(0~1)	0	0:Normally open; 1:Normally close
Sync Setting -Basic				
1	Voltage Difference	(0-30)V	3	Voltage difference between generator and mains. It is considered voltage synchronization when the voltage difference between generator and mains is lower than voltage difference value.
2	Positive Freq Difference	(0-2.0)Hz	0.2	Frequency difference between generator and mains. It is considered frequency synchronization when the frequency difference between generator and mains is less than Check Up Freq but more than Check Low Freq.
3	Negative Freq Difference	(0-2.0)Hz	0.1	
4	Phase Angle Difference	(0-20)°	10	Initial phase difference between generator and mains. It is considered Check Phase Angle when the initial phase difference is lower than phase angle difference value.
5	Slip Frequency	(0-1.00)Hz	0.10	Adjust generator frequency and enable it greater than slip frequency of mains.
6	Load Ramp Rate	(0-100.0)%	3.0	Speed rate of genset upload/unload
7	Fail to Sync Delay	(5.0-300.0)s	60.0	When the controller detects no Sync signal during the preset delay, it will send corresponding alarm signal according to the action type. Action Type: 0: Warn; 1: Shutdown.
8	Fail to Sync Action	(0-1)	0	
9	Load Mode	(0-2)	0	0: Generator; 1: Mains; 2: Takeover.
10	Output Active Power	(0-100.0)%	30.0	Used for load control.
11	Reactive Power Control	(0-1)	0	0: kVAr control; 1: PF control
12	Reactive Power range	(0-100.0)%	8.0	Used for load control.
Sync Setting - GOV				
1	Output Type	(0-1)	1	0: Internal Relays; 1: Internal Analogue
2	Output Reverse	(0-1)	0	0: Disable; 1: Enable.
3	Action	(0-2)	1	0: None; 1: Adjust to Rated Frequency; 2: Adjust to Center Point
4	Center Voltage SW1	(0-10.0)	0	Default central voltage: 0V.
5	Voltage Range SW2	(0-10.0)	2.0	Default volt. range: (-2.5~+2.5)V

No.	Items	Parameters	Defaults	Description
6	Sync Gain	(0-500)	20	Adjust and control before paralleling.
7	Sync Stability	(0-2000)	20	Adjust and control before paralleling.
8	Load Gain	(0-500)	20	Adjust and control after paralleling.
9	Load Stability	(0-2000)	20	Adjust and control after paralleling.
Sync Setting - AVR				
1	Output Type	(0-2)	2	0: None 1: Internal Relays; 2: Internal Analogue
2	Output Reverse	(0-1)	0	0: Disable; 1: Enable.
3	Action	(0-2)	1	0: None; 1: Adjust to Rated Frequency; 2: Adjust to Center Point
4	Center Voltage SW1	(0-10.0)	0	Default central voltage: 0V.
5	Voltage Range SW2	(0-10.0)	2.0	Default volt. range: (-2.5~+2.5)V
6	Sync Gain	(0-500)	20	Adjust and control before paralleling.
7	Sync Stability	(0-2000)	20	Adjust and control before paralleling.
8	Load Gain	(0-500)	20	Adjust and control after paralleling.
9	Load Stability	(0-2000)	20	Adjust and control after paralleling.

▲Note: overcurrent setting details about definite time delay and inverse definite minimum time are as following.

Definite Time: overcurrent delay is definite time delay. Different overcurrent value has corresponding delay.

Inverse Definite Minimum Time(IDMT): overcurrent delay decrease with the increase of overcurrent. Different overcurrent value has corresponding delay.

IDMT formula:

$$T = t / ((IA/IT)-1)^2$$

T: Overcurrent delay (second)

t: Timing multiplier ratio

IA: Present maximum load current (L1/L2/L3)

IT: Overcurrent setting value

Example:

$$t = 36$$

$$IA = 550A$$

$$IT = 500A$$

Conclusion: T = 3600s (1hour)

8.2 PROGRAMMABLE OUTPUT PORTS

Form 2

No.	Type	Description
0	Not Used	
1	Custom Period 1	Details of function description please see the following.
2	Custom Period 2	
3	Custom Period 3	
4	Custom Period 4	
5	Custom Period 5	
6	Custom Period 6	
7	Custom Combined 1	
8	Custom Combined 2	
9	Custom Combined 3	
10	Custom Combined 4	
11	Custom Combined 5	
12	Custom Combined 6	
13	Reserved	
14	Reserved	
15	Reserved	
16	Reserved	
17	Air Flap Control	Action when over speed shutdown and emergence stop. It also can close the air inflow to stop the engine as soon as possible.
18	Audible Alarm	Action when warning, shutdown, trips. Can be connected annunciator externally. When "alarm mute" configurable input port is active, it can remove the alarm.
19	Louver Control	Action when genset start and disconnect when genset stopped completely.
20	Fuel Pump Control	It is controlled by limited threshold of fuel pump.
21	Heater Control	It is controlled by limited threshold of heater.
22	Cooler Control	It is controlled by limited threshold of cooler.
23	Oil Pre-supply Output	Action from "crank on" to "safety on".
24	Generator Excite	Output in start period. If there is no generator frequency during hi-speed running, then output for 2 seconds again.
25	Pre-Lubricate	Actions in period of pre-heating to safety run.
26	Remote Control Output	This port is controlled by communication (PC).
27	GSM Power Supply	Power for GSM module (GSM module is reset when GSM communication failed).
28	Reserved	
29	Close Gen Output	Control generator to take load.
30	Open Gen Output	Control generator to off load.
31	Close Mains Output	Control mains to take load.

HGM9520 Genset Parallel (With Mains) Unit

32	Open Mains Output	Control mains to off load.
33	Start Relay	
34	Fuel Relay	Action when genset start and disconnect when genset stop completely.
35	Idle Control	Used for engine which has idles. Close before starting and open in warming up delay; Close during stopping idle process and open when stop is completed.
36	Speed Raise Relay	Action in warming up delay.
37	Speed Drop Relay	Action between the period from “stop idle” to “failed to stop”.
38	Energize to Stop	Used for engines with ETS electromagnet. Close when stop idle is over and open when pre-set “ETS delay” is over.
39	Speed Drop Pulse	Active 0.1s when controller enters into stop idle, used for control part of ECU dropping to idle speed.
40	ECU Stop	Used for ECU engine and control its stop.
41	ECU Power Supply	Used for ECU engine and control its power.
42	Speed Raise Pulse	Active 0.1s when controller enters into warming up delay; used for control part of ECU raising to normal speed.
43	Crank Success	Close when detects a successful start signal.
44	Generator OK	Action when generator is normal.
45	Generator Load Available	Action in period of generator normal running to hi-speed cooling.
46	Mains OK	Action when mains is normal.
47	Synchronizing	Action when controller is synchronizing.
48	Common Alarm	Action when genset common warning, common shutdown or common trips alarm occurs.
49	Common Trip and Stop	Action when common trip and stop alarm occurs.
50	Common Shutdown	Action when common shutdown alarm occurs.
51	Common Trip	Action when common trips alarm occurs.
52	Common Warn	Action when common warning alarm occurs.
53	Reserved	
54	Battery Over Voltage	Action when battery’s over voltage warning alarm occurs.
55	Battery Under Voltage	Action when battery’s low voltage warning alarm occurs.
56	Charge Alternator Failure	Action when charge failure warning alarm occurs.
57	Reserved	
58	Reserved	
59	Reserved	
60	ECU Warning	Indicate ECU sends a warning signal.
61	ECU Shutdown	Indicate ECU sends a shutdown signal.
62	ECU Com Fail	Indicate controller not communicates with ECU.
63	PWM Voltage Raise	When output type of AVR set as “Relay output”,

HGM9520 Genset Parallel (With Mains) Unit

64	PWM Voltage Drop	controller adjust voltage and reactive power via “Sync Raise Volt” and “Sync Drop Volt”
65	PWM Speed Raise	When output type of GOV set as “Relay output”, controller adjust speed and power via “Sync Raise Speed” and “Sync Drop Speed”
66	PWM Speed Drop	
67	Reserved	
68	Reserved	
69	Digital Input 1 Active	Action when input port 1 is active
70	Digital Input 2 Active	Action when input port 2 is active
71	Digital Input 3 Active	Action when input port 3 is active
72	Digital Input 4 Active	Action when input port 4 is active
73	Digital Input 5 Active	Action when input port 5 is active
74	Digital Input 6 Active	Action when input port 6 is active
75	Digital Input 7 Active	Action when input port 7 is active
76	Digital Input 8 Active	Action when input port 8 is active
77~98	Reserved	
99	Emergency Stop	Action when emergency stop alarm.
100	Fail To Start	Action when start failure alarm.
101	Fail To Stop	Action when stop failure alarm.
102	Under Speed Warn	Action when under speed alarm.
103	Under Speed Shutdown	Action when under speed shutdown alarm.
104	Over Speed Warn	Action when over speed warns.
105	Over Speed Shutdown	Action when over speed shutdown alarm.
106	Reserved	
107	Reserved	
108	Reserved	
109	Gen Over Freq. Warn	Action when generator over frequency warning occurs.
110	Gen over Freq. Shut	Action when generator over frequency shutdown alarm occurs.
111	Gen Over Volt Warn	Action when generator over voltage warning occurs.
112	Gen Over Volt Shut	Action when generator over voltage shutdown occurs.
113	Gen Under Freq. Warn	Action when generator low frequency warning occurs.
114	Gen Under Freq. Shut	Action when generator low frequency shutdown occurs.
115	Gen Under Volt. Warn	Action when generator low voltage warning occurs.
116	Gen Under Volt. Shut	Action when generator low voltage shutdown occurs.
117	Gen Loss of Phase	Action when generator loss phase.
118	Gen Phase Sequence Wrong	Action when generator reverse phase.
119	Reserved	
120	Over Power	Action when controller detects generator over

HGM9520 Genset Parallel (With Mains) Unit

		power occurs.
121	Reserved	
122	Generator Reverse Power	Action when controller detects generator have reverse power.
123	Over Current	Action when generator over current occurs.
124	Reserved	
125	Mains Inactive	
126	Mains Over Freq	
127	Mains Over Volt	
128	Mains Under Freq	
129	Mains Under Volt	
130	Phase Sequence Wrong	
131	Mains Loss of Phase	
132~138	Reserved	
139	High Temp Warn	Action when hi-temperature warning occurs.
140	Low Temp Warn	Action when low temperature warning occurs.
141	High Temp Shutdown	Action when hi-temperature shutdown alarm occurs.
142	Reserved	
143	Low OP Warn	Action when low oil pressure warning occurs.
144	Low OP Shutdown	Action when low oil pressure shutdown alarm occurs.
145	Oil Pressure Open Circuit	Action when oil pressure sensor is open circuit.
146	Reserved	
147	Low Fuel Level	Action when low fuel level alarm occurs.
148	Reserved	
149	Reserved	
150	Flexible Sensor 1 High Warn	
151	Flexible Sensor 1 Low Warn	
152	Flexible Sensor 1 High Shut	
153	Flexible Sensor 1 Low Shut	
154	Flexible Sensor 2 High Warn	
155	Flexible Sensor 2 Low Warn	
156	Flexible Sensor 2 High Shut	
157	Flexible Sensor 2 Low Shut	
158~229	Reserved	
230	Stop Mode	Action in stop mode.
231	Manual Mode	Action in Manual mode.
232	Reserved	
233	Auto Mode	Action in Auto mode.
234	Generator Load	
235	Mains Load	
236~239	Reserved	

8.2.1 DEFINED PERIOD OUTPUT

Defined Period output is composed by 2 parts, period output S1 and condition output S2.



While S1 and S2 are **TRUE** synchronously, OUTPUT;

While S1 or S2 is **FALSE**, NOT OUTPUT.

Period output S1, can set generator's one or more period output freely, can set the delayed time and output time after enter into period.

Condition output S2, can be set as any item is given in the section entitled *Programmable Output Ports* elsewhere in this manual.

▲**NOTE:** when delay time and output time both are 0 in period output S1, means it is **TRUE** in this period.

Example:

Output period: start

Delay time: 2s

Output time: 3s

Condition output contents: output port 1 is active

Close when condition output active/inactive: close when active (disconnect when inactive);

Output port 1 active: after enter "starting time" and delay 2s, this defined period output is outputting, after 3s, stop outputting;

Output port 1 inactive: defined output period is not outputting.

8.2.2 DEFINED COMBINATION OUTPUT

Defined combination output is composed by 3 parts, condition output S1 or S2 and condition output S3.

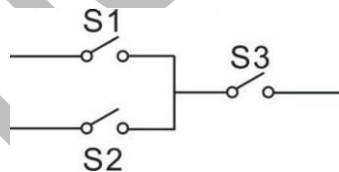

S1 or S2 is **TRUE**, while S3 is **TRUE**, Defined combination output is outputting;

S1 and S2 are **FALSE**, or S3 is **FALSE**, Defined combination output is not outputting.

▲**NOTE:** S1, S2, S3 can be set as any item except for "defined combination output" which is given in the section entitled *Programmable Output Ports* elsewhere in this manual.

▲**NOTE:** 3 parts of defined combination output (S1, S2, S3) couldn't include or recursively include themselves.

Example,

Contents of condition output S1: output port 1 is active;

Close when condition output S1 is active /inactive: close when active (disconnect when inactive);

Contents of condition output S2: output port 2 is active;

Close when condition output S2 is active /inactive: close when active (disconnect when inactive);

Contents of condition output S3: output port 3 is active;

Close when condition output S3 is active /inactive: close when active (disconnect when inactive);





When input port 1 active or input port 2 active, if input port 3 is active, Defined Combination Output is outputting; If input port 3 inactive, Defined Combination Output is not outputting;

When input port 1 inactive and moreover, input port 2 inactive, whatever input port 3 is active or not, Defined Combination Output is not outputting.

SmartGen

8.3 PROGRAMMABLE INPUT PORTS (ALL ACTIVE WHEN CONNECT TO GRAND (B-))

Form 3

No.	Type	Description
0	Users Configured	Including following functions, Indication: indicate only, not warning or shutdown. Warning: warn only, not shutdown. Shutdown: alarm and shutdown immediately Trip and stop: alarm, generator unloads and shutdown after hi-speed cooling Trip: alarm, generator unloads but not shutdown. Never: input inactive. Always: input is active all the time. From crank: detecting from generator start. From safety on: detecting after safety on delay.
1	Reserved	
2	Alarm Mute	Can prohibit "Audible Alarm" output when input is active.
3	Reset Alarm	Can reset shutdown alarm and trip alarm when input is active.
4	60Hz Active	Use for CANBUS engine and it is 60Hz when input is active.
5	Lamp Test	All LED indicators are illuminating when input is active.
6	Panel Lock	All buttons in panel is inactive except  and there is  in the left of first row in LCD when input is active.
7	Reserved	
8	Idle Control Mode	Under voltage/frequency/speed protection is inactive.
9	Inhibit Auto Stop	In Auto mode, during generator normal running, when input is active, prohibit generator shutdown automatically.
10	Inhibit Auto Start	In Auto mode, prohibit generator start automatically when input is active.
11	Inhibit Scheduled	In Auto mode, prohibit fixed timing start genset when input is active.
12	Reserved	
13	Aux Gen Closed	Connect generator loading switch's auxiliary point.
14	Inhibit Gen Load	Prohibit genset switch on when input is active.
15	Aux Mains Closed	Connect mains loading switch's auxiliary point.
16	Inhibit Mains Load	Prohibit mains switch on when input is active.
17	Auto Mode Lock	When input is active, controller enters into Auto Mode; all the keys except  are inactive.
18	Auto Mode Invalid	When input is active, controller won't work under Auto Mode.  key and simulate auto key input does not work.

HGM9520 Genset Parallel (With Mains) Unit

19	Reserved	
20	Reserved	
21	Inhibit Alarm Stop	All shutdown alarms are prohibited except emergency stop.(i.e. battle mode)
22	Aux Instrument Mode	All outputs are prohibited in this mode.
23	Reserved	
24	Reset Maintenance	Controller will set maintenance time and date as default when input is active.
25	Reserved	
26	Aux. High Temp	Connect to sensor digital input.
27	Aux. Low OP	Connect to sensor digital input.
28	Remote Start (On Load)	In Auto mode, when input is active, can start genset automatically and with load when genset is normal running; when input is inactive, can stop genset automatically.
29	Remote Start (Off Load)	In Auto mode, when input is active, can start genset automatically and off load when genset is normal running; when input is inactive, can stop genset automatically.
30	Aux. Manual Start	In Manual mode, when input is active, can start genset automatically; when input is inactive, can stop genset automatically.
31	Remote Start (Demand)	In Auto mode, when input is active, can start or stop genset automatically according to the load condition.
32	Remote Start (Island)	In Auto mode, when input is active, can start genset automatically and with load when genset is normal running, moreover, mains unload; when input is inactive, mains take load while generator unload and stop genset automatically.
33	Simulate Stop key	An external button (not latched) can be connected to simulate panel button.
34	Simulate Manual key	
35	Reserved	
36	Simulate Auto key	An external button (not latched) can be connected to simulate panel button.
37	Simulate Start key	
38	Simulate G-Load key	
39	Simulate M-Load key	
40-44	Reserved	
45	Auxiliary Mains OK	In Auto mode, mains is ok when the input is active.
46	Auxiliary Mains Fail	In Auto mode, mains is abnormal when the input is active.
47	Alternative Config1	Alternative configuration is active when the input is active. Users can set different parameters to make it easy to select current configuration via input port.
48	Alternative Config2	
49	Alternative Config3	
50	Reserved	

8.4 SELECTION OF SENSORS

Form4

No.		Description	Remark
1	Temperature Sensor	0 Not used 1 Custom Res Curve 2 Custom 4-20mA curve 3 VDO 4 CURTIS 5 VOLVO-EC 6 DATCON 7 SGX 8 SGD 9 SGH 10 PT100 11~15 Reserved	Defined resistance's range is 0~6KΩ, default is SGX sensor.
2	Pressure Sensor	0 Not used 1 Custom Res Curve 2 Custom 4-20mA curve 3 VDO 10Bar 4 CURTIS 5 VOLVO-EC 6 DATCON 10Bar 7 SGX 8 SGD 9 SGH 10~15 Reserved	Defined resistance's range is 0~6KΩ, default is SGX sensor.
3	Fuel Level Sensor	0 Not used 1 Custom Res Curve 2 Custom 4-20mA curve 3 SGD 4 SGH 5~15 Reserved	Defined resistance's range is 0~6KΩ, default is SGH sensor.

NOTE: User should make special declare when order controller if your genset equip with 4~20mA sensor.

8.5 CONDITIONS OF CRANK DISCONNECT SELECTION

No.	Setting description
0	Generator Frequency
1	Engine Speed
2	Engine Speed + Generator Frequency
3	Oil pressure
4	Oil pressure + Generator Frequency
5	Oil pressure + Engine Speed
6	Oil pressure + Engine Speed + Generator Frequency

▲NOTE:

- There are 3 conditions to make starter disconnected with engine, that is, engine speed, generator frequency and oil pressure. They all can be used separately. We recommend that oil pressure should be using with speed sensor and generator frequency together, in order to make the starter separate with engine as soon as possible and can check start exactly.
- Speed sensor is the magnetic equipment which be installed in starter for detecting flywheel teeth.
- When set as engine speed, must ensure that the number of flywheel teeth is as same as setting, otherwise, "over speed stop" or "under speed stop" may be caused.
- If genset without speed sensor, please don't select corresponding items which include *engine speed*, otherwise, "start fail" or "loss of speed signal" maybe caused.
- If genset without oil pressure sensor, please don't select corresponding items which include *oil pressure*.
- If not select generator frequency in crank disconnect setting, controller will not collect and display the relative power quantity (can be used in water pump set); if not select engine speed in crank disconnect setting, the rotating speed displayed on LCD is calculated by generator frequency and number of poles.

9 PARAMETERS SETTING

▲CAUTION: Please change the controller parameters when generator is in standby mode only (e. g. Crank disconnect conditions selection, configurable input, configurable output, various delay), otherwise, shutdown alarm or other abnormal conditions may occur.

▲NOTE: Maximum set value must greater than minimum set value in case that the condition of too high as well as too low may occur.

▲NOTE: When setting the warning alarm, please set the correct return value; otherwise, maybe abnormal alarm occurs. When setting the maximum value, the return value must less than set value; When setting the minimum value, the return value must greater than set value.

▲NOTE: Please set the generator frequency value as low as possible when cranking, in order to make the starter separate with engine as soon as possible.

▲NOTE: Configurable input ports could not be set as same items; otherwise, abnormal functions occur. However, the configurable output ports can be set as same items.

10 SENSORS SETTING

- 1) When reselect sensors, the sensor curve will be transferred into the standard value. For example, if default temperature sensor is SGX (120°C resistor type), its sensor curve is SGX (120°C resistor type); if select the SGD (120°C resistor type), the temperature sensor curve is SGD curve.
- 2) When there is difference between standard sensor curves and using one, user can adjust it in “curve type”.
- 3) When input the sensor curve, X value (resistor) must be input from small to large, otherwise, mistake occurs.
- 4) If select sensor type as “None”, sensor curve is not working.
- 5) If corresponding sensor has alarm switch only, user must set this sensor as “None”, otherwise, shutdown or warning alarm occurs.
- 6) The headmost or backmost values in the vertical coordinates can be set as the same one, as shown below,

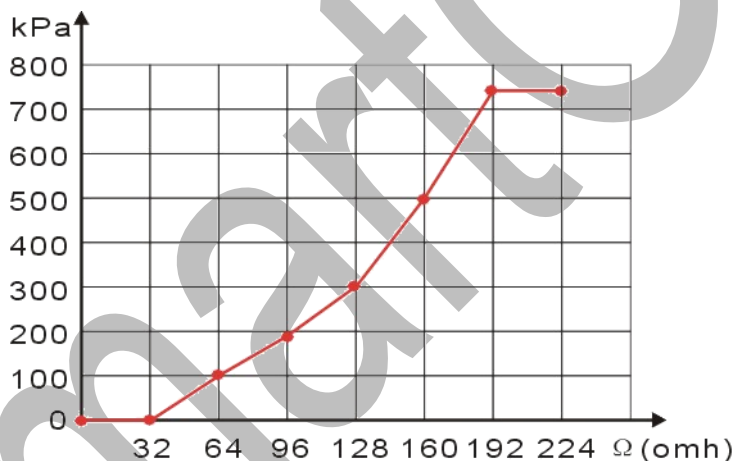

Normal Pressure Unit Conversion Form

	pa	kgf/cm ²	bar	psi
1Pa	1	1.02×10^{-5}	1×10^{-5}	1.45×10^{-4}
1kgf/cm ²	9.8×10^4	1	0.98	14.2
1bar	1×10^5	1.02	1	14.5
1psi	6.89×10^3	7.03×10^{-2}	6.89×10^{-2}	1

11 COMMISSIONING

11.1 STEP 1. GENSET DEBUGGING

- 1) Check the parameter configuration of the controller;
- 2) Check wiring;
- 3) Start genset manually, check if engine and generator data is normal;
- 4) Start genset manually, check if generator/mains switch opens and closes normally;
- 5) Start genset manually, after closing the breaker check if generator frequency can be adjusted to the rated frequency (e.g. set the rated frequency as 52Hz, 48Hz);
- 6) Start genset manually, after closing the breaker check if generator voltage can be adjusted to the rated voltage (e.g. set the rated voltage as 240V, 220V);
- 7) Activate manual start on-load, check if power factor, active power and reactive power are normal; if negative value occurs, check phase sequence of generator voltage and current, the direction of current transformer's incoming line, the dotted terminal of current transformer's secondary current;
- 8) Start genset manually, do performance tests according to the national standards.

▲ Note: Please refer to HGM6500 Synchronization Plan List for more information on GOV and AVR settings.

11.2 STEP 2: MANUAL PARALLEL OPERATION OFF-LOAD

- 1) Set the controller as generator control mode, active power as 0% and reactive power as 0%;
- 2) During parallel operation off load, check if the active and reactive power is equal to zero;

11.3 STEP 3: MANUAL PARALLEL OPERATION ON-LOAD

- 1) Set the controller as generator control mode, active power as 50% and reactive power as 20%;
- 2) After manual parallel operation off load, check if the genset output active power is 50% and reactive power is 20%.

12 MAINS PARALLEL

12.1 GENSET CONTROL MODE

Output set active power, reactive power and power factor.

Fixed Power Output

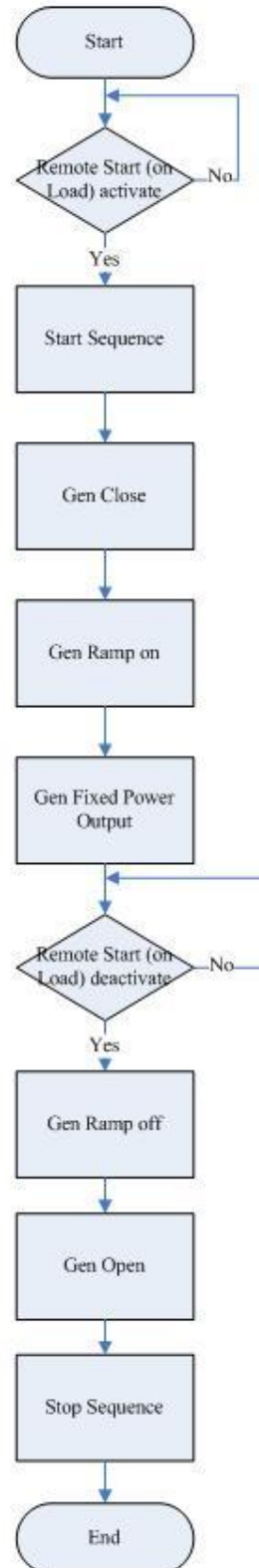

12.2 MAINS CONTROL MODE

Set the mains on load power value. Once over the set value, genset will share the spare power. Make sure that controller soundly connect to mains CT.

Mains Peak Lopping

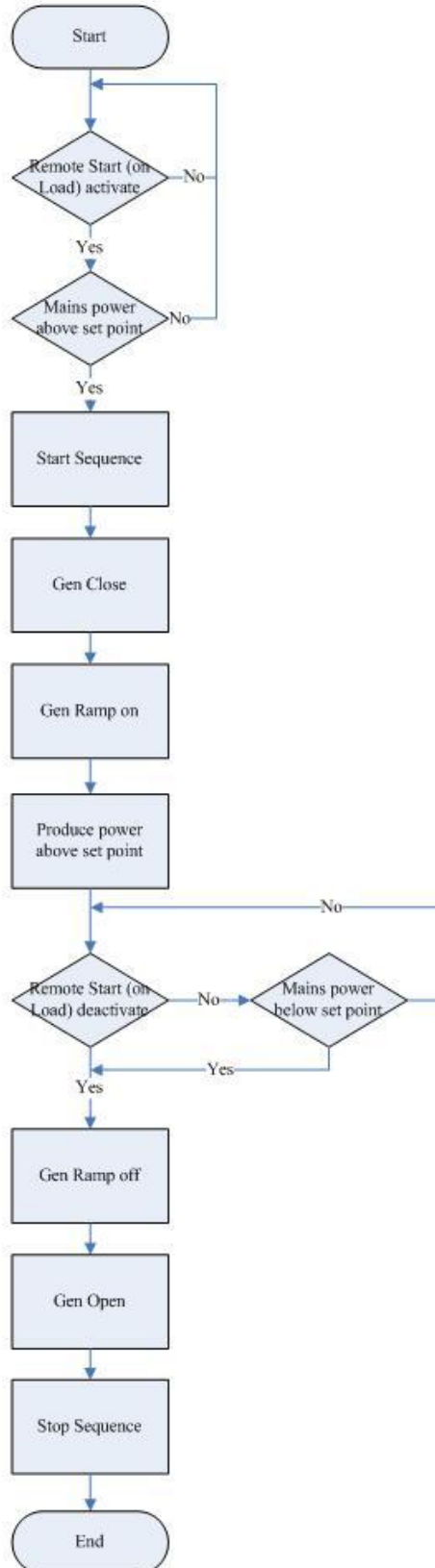

12.3 LOAD TAKEOVER MODE

Make sure that controller soundly connect to mains CT.

Load Takeover Mode

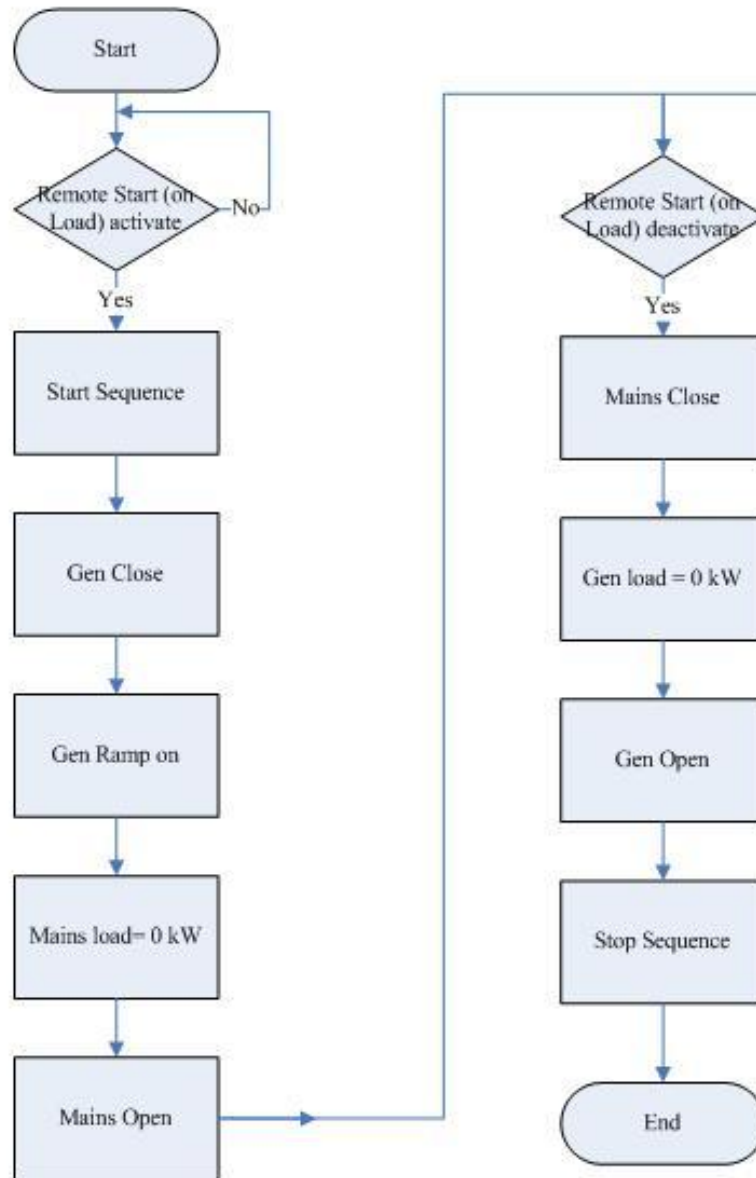

12.4 AMF MODE

Automatic Mains Failure

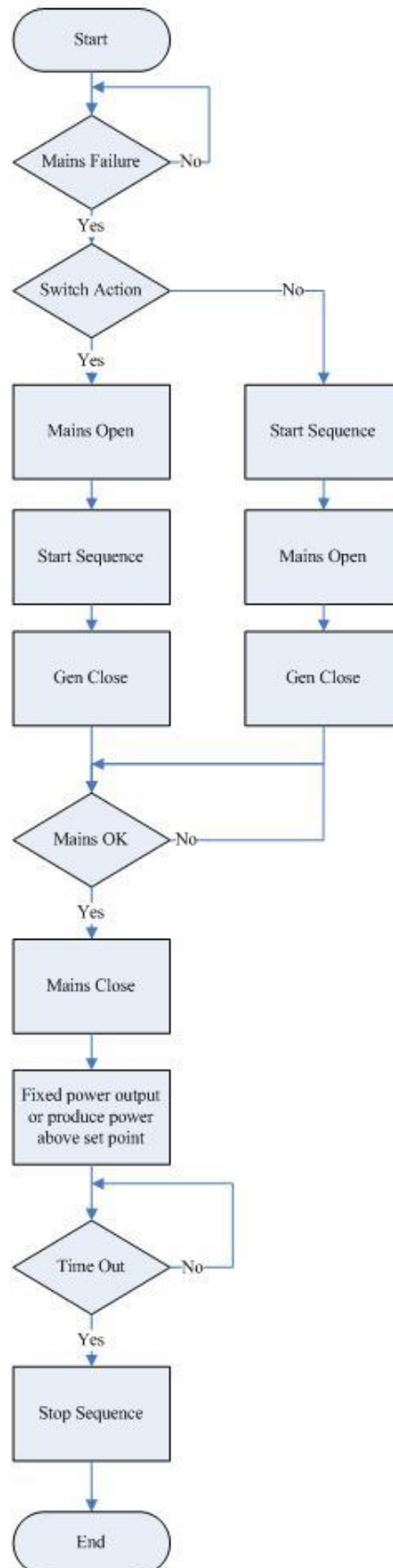

12.5 ISLAND MODE

Island Output

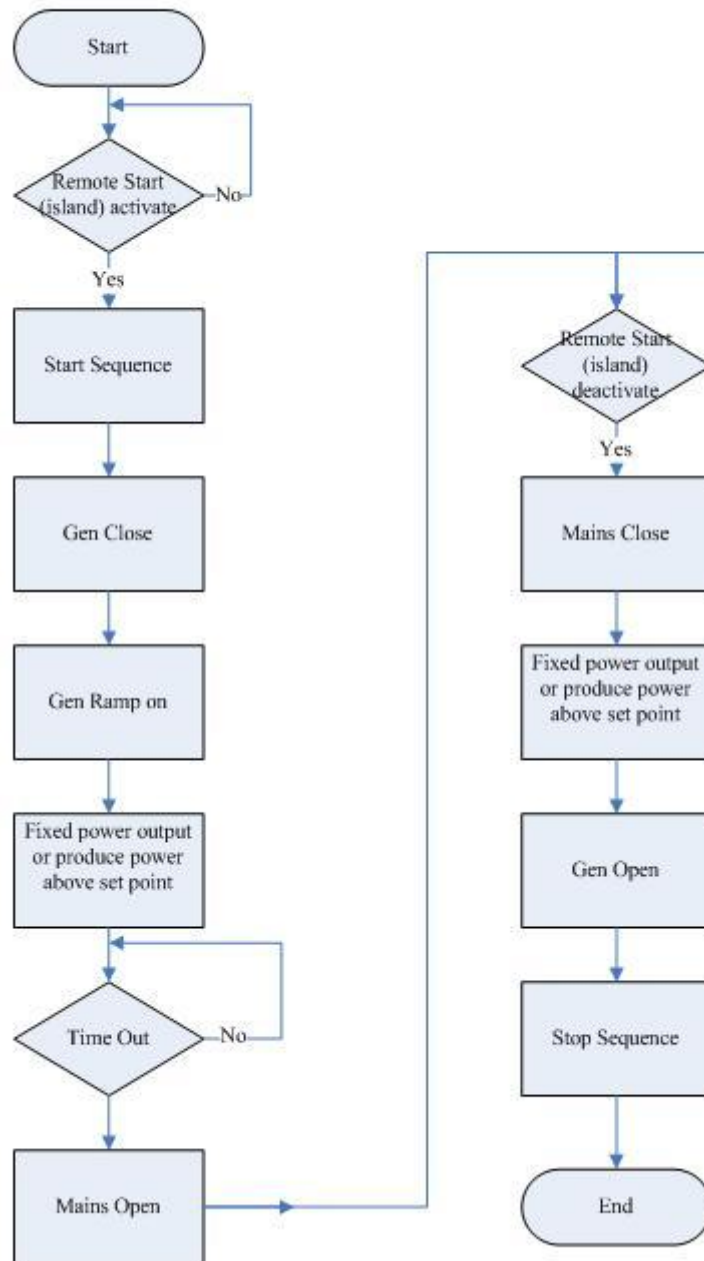

13 TYPICAL APPLICATION

HGM9520 Typical Application Diagram

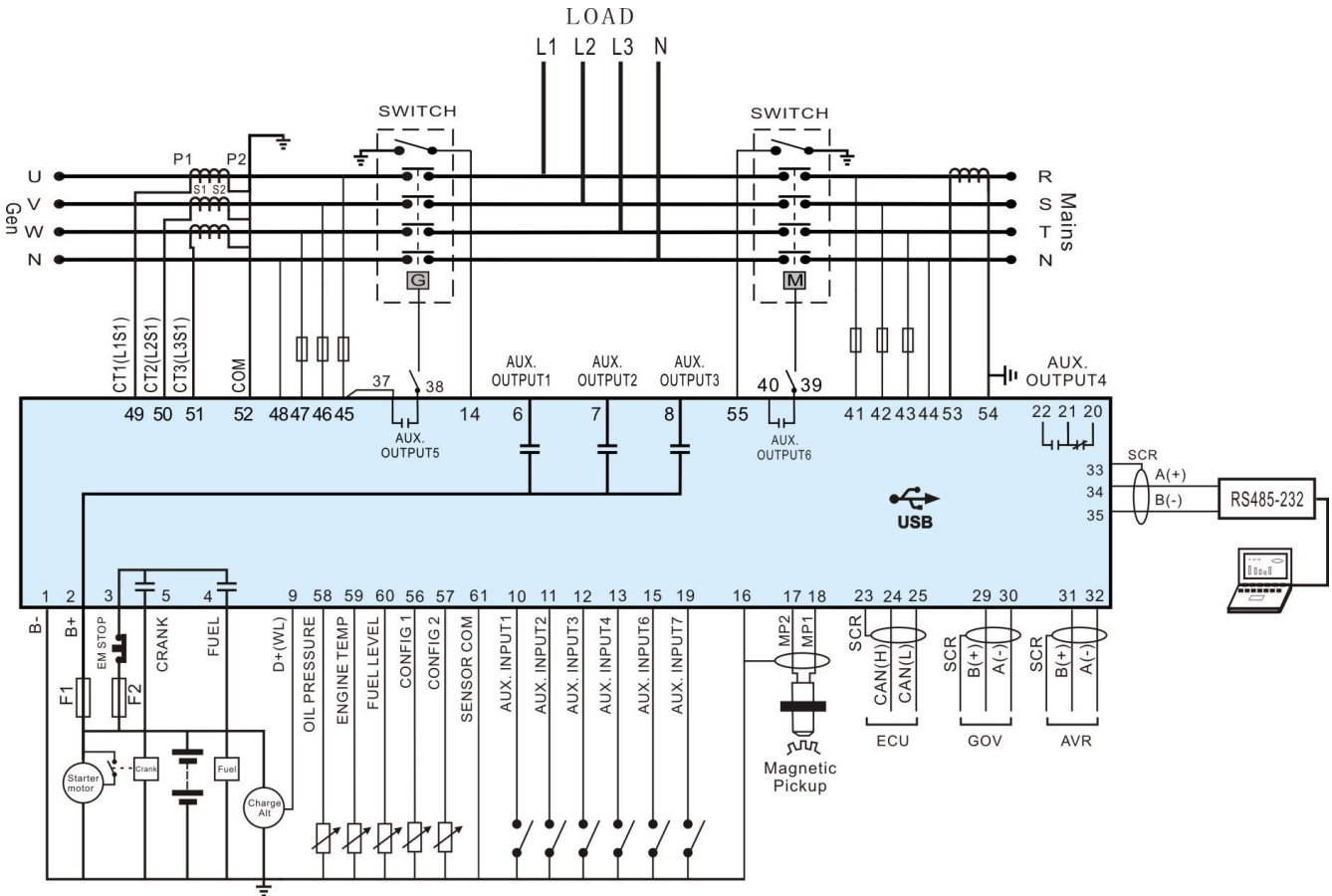

Note: Fuse F1: min. 2A; max. 20A. Fuse F2: max. 32A. Users should select suitable fuse depend on practical application.

3 Phase 3 Wire

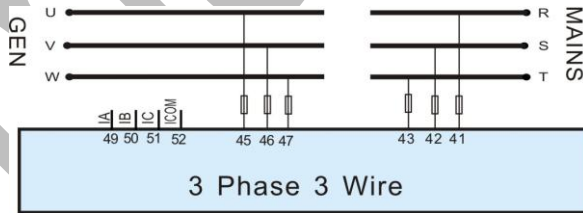

2 Phase 3 Wire

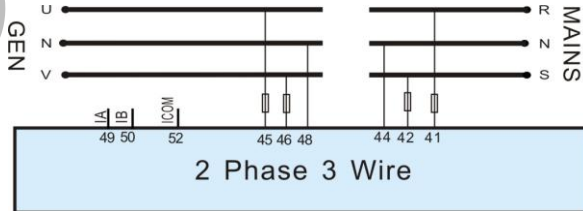

Single Phase 2 Wire

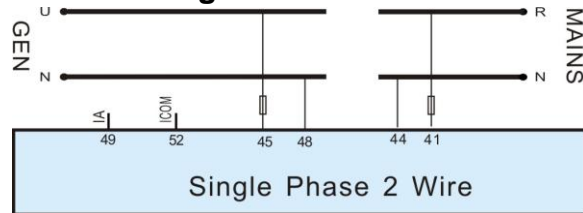

14 INSTALLATION

Controller is panel built-in design; it is fixed by clips when installed. The controller's overall dimensions and cutout dimensions for panel, please refers to as following,

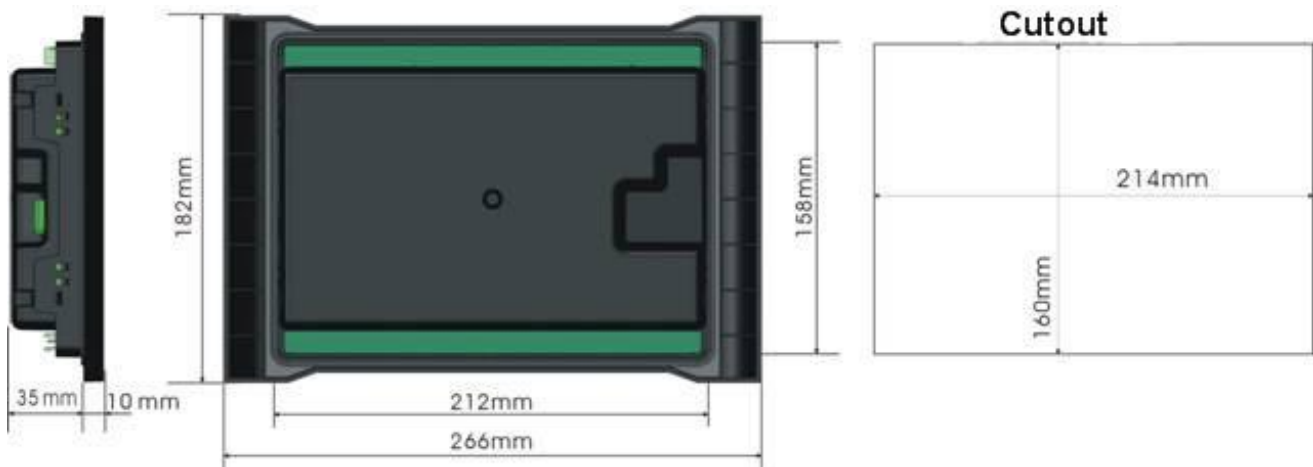

1) Battery Voltage Input

▲NOTE: HGM9520 controller can suit for widely range of battery voltage DC(8~35)V. Negative of battery must be connected with the shell of starter. The wire's diameter connect controller and battery must be over 2.5mm^2 . If floating charger configured, please firstly connect output wires of charger to battery's positive and negative directly, then, connect wires from battery's positive and negative to controller's corresponding ports in order to prevent the charger interfere with the normal operation of the controller.

2) Speed Sensor Input

▲NOTE: Speed sensor is the magnetic equipment which be installed in starter and for detecting flywheel teeth. Its connection wires to controller should apply for 2 cores shielding line. The shielding layer should connect to No. 16 terminal in controller while another side is hanging in air. The else two signal wires are connected to No.17 and No.18 terminals in controller. The output voltage of speed sensor should be within AC (1~24)V (effective value) during the full speed. AC12V is recommended (in rated speed). When install the speed sensor, spun the sensor until only the pointed end is protruding from the flywheel, then, withdraw 1/3 lap, and lock the nuts of the sensor at last.

3) Output And Expand Relays

▲CAUTION: All outputs of controller are relay contact output. If need to expand the relays, please add freewheel diode to both ends of expand relay's coils (when relay coils has DC current) or, increase resistance-capacitance return circuit (when relay coils has AC current), in order to prevent disturbance to controller or others equipment.

4) AC Input

Current transformer must be connected externally and the current transformer's secondary side current must be 5A. At the same time, the phases of current transformer and input voltage must correct. Otherwise, the collected current and active power maybe not correct.

 **NOTE:** ICOM port must be connected to negative pole of battery.

 **WARNING!** When there is load current, transformer's secondary side prohibit open circuit.

5) Withstand Voltage Test

 **CAUTION!** When controller had been installed in control panel, if need the high voltage test, please disconnect controller's all terminal connections, in order to prevent high voltage into controller and damage it.

SmartGen

15 CONNECTIONS OF CONTROLLER WITH J1939 ENGINE

15.1 CUMMINS ISB/ISBE

Terminals of controller	Connector B	Remark
Fuel relay output	39	
Start relay output	-	Connect with starter coil directly
Auxiliary output port 1	Expand 30A relay, battery voltage of 01,07,12,13 is supplied by relay	ECU power Set configurable output 1 as "ECU power"

Terminals of controller	9 pins connector	Remark
CAN GND	SAE J1939 shield	CAN communication shielding line (connect with ECU side only)
CAN(H)	SAE J1939 signal	Impedance 120Ω connecting line is recommended.
CAN(L)	SAE J1939 return	Impedance 120Ω connecting line is recommended.

Engine type: Cummins ISB

15.2 CUMMINS QSL9

Suitable for CM850 engine control module

Terminals of controller	50 pins connector	Remark
Fuel relay output	39	
Start relay output	-	Connect to starter coil directly

Terminals of controller	9 pins connector	Remark
CAN GND	SAE J1939 shield-E	CAN communication shielding line (connect with ECU side only)
CAN(H)	SAE J1939 signal-C	Impedance 120Ω connecting line is recommended.
CAN(L)	SAE J1939 return-D	Impedance 120Ω connecting line is recommended.

Engine type: Cummins-CM850

15.3 CUMMINS QSM11 (IMPORT)

It is suitable for CM570 engine control module. Engine type is QSM11 G1, QSM11 G2.

Terminals of controller	C1 connector	Remark
Fuel relay output	5&8	Outside expand relay; When fuel output, making port 5 and port 8 of C1 be connected.
Start relay output	-	Connect to starter coil directly

Terminals of controller	3 pins data link connector	Remark
CAN GND	C	CAN communication shielding line (connect with ECU side only)
CAN(H)	A	Impedance 120Ω connecting line is recommended.
CAN(L)	B	Impedance 120Ω connecting line is recommended.

Engine type: Cummins ISB

15.4 CUMMINS QSX15-CM570

It is suitable for CM570 engine control module. Engine type is QSX15.

Terminals of controller	50 pins connector	Remark
Fuel relay output	38	Oil spout switch
Start relay output	-	Connect to starter coil directly

Terminals of controller	9 pins connector	Remark
CAN GND	SAE J1939 shield-E	CAN communication shielding line (connect with ECU side only)
CAN(H)	SAE J1939 signal-C	Impedance 120Ω connecting line is recommended.
CAN(L)	SAE J1939 return-D	Impedance 120Ω connecting line is recommended.

Engine type: Cummins QSX15-CM570

15.5 CUMMINS GCS-MODBUS

It is suitable for GCS engine control module. Use RS485-MODBUS to read engine information. Engine types are QSX15, QST30, QSK23/45/60/78 and so on.

Terminals of controller	D-SUB connector 06	Remark
Fuel relay output	5&8	Outside expand relay; When fuel output, making port 05 and 08 of the connector 06 be connected.
Start relay output	-	Connect to starter coil directly

Terminals of controller	D-SUB connector 06	Remark
RS485 GND	20	CAN communication shielding line(connect with ECU side only)
RS485+	21	Impedance 120Ω connecting line is recommended.
RS485-	18	Impedance 120Ω connecting line is recommended.

Engine type: Cummins QSK-MODBUS, Cummins QST-MODBUS, Cummins QSX-MODBUS

15.6 CUMMINS QSM11

Terminals of controller	OEM connector of engine	Remark
Fuel relay output	38	
Start relay output	-	Connect with starter coil directly
CAN GND	-	CAN communication shielding line (connect with controller at controller's side only)
CAN(H)	46	Impedance 120Ω connecting line is recommended.
CAN(L)	37	Impedance 120Ω connecting line is recommended.

Engine type: common J1939

15.7 CUMMINS QSZ13

Terminals of controller	OEM connector of engine	Remark
Fuel relay output	45	
Start relay output	-	Connect to starter coil directly
Programmable output 1	16&41	Setting to idle speed control, normally close output. Making 16 connect to 41 during high-speed running of controller via external expansion relay.
Programmable output 2	19&41	Setting to pulse raise speed control, normally open output. Making 19 connect with 41 for 0.1s during high-speed warming of controller via external expansion relay.
CAN GND	-	CAN communication shielding line(connect with controller at controller's side only)
CAN(H)	1	Impedance 120Ω connecting line is recommended.
CAN(L)	21	Impedance 120Ω connecting line is recommended.

Engine type: Common J1939**15.8 DETROIT DIESEL DDEC III / IV**

Terminals of controller	CAN port of engine	Remark
Fuel relay output	Expand 30A relay, battery voltage of ECU is supplied by relay	
Start relay output	-	Connect to starter coil directly
CAN GND	-	CAN communication shielding line(connect with controller at controller's side only)
CAN(H)	CAN(H)	Impedance 120Ω connecting line is recommended.
CAN(L)	CAN(L)	Impedance 120Ω connecting line is recommended.

Engine type: Common J1939

15.9 DEUTZ EMR2

Terminals of controller	F connector	Remark
Fuel relay output	Expand 30A relay, battery voltage of terminal 14 is supplied by relay. Fuse is 16A.	
Start relay output	-	Connect to starter coil directly
-	1	Connect to battery negative pole
CAN GND	-	CAN communication shielding line(connect with controller at controller's side only)
CAN(H)	12	Impedance 120Ω connecting line is recommended.
CAN(L)	13	Impedance 120Ω connecting line is recommended.

Engine type: VolvoEDC4**15.10 JOHN DEERE**

Terminals of controller	21 pins connector	Remark
Fuel relay output	G,J	
Start relay output	D	
CAN GND	-	CAN communication shielding line(connect with controller at controller's side only)
CAN(H)	V	Impedance 120Ω connecting line is recommended.
CAN(L)	U	Impedance 120Ω connecting line is recommended.

Engine type: John Deere**15.11 MTU MDEC**

Suitable for MTU 2000 series and 4000 series engines.

Terminals of controller	X1 connector	Remark
Fuel relay output	BE1	
Start relay output	BE9	
CAN GND	E	CAN communication shielding line(connect with one side only)
CAN(H)	G	Impedance 120Ω connecting line is recommended.
CAN(L)	F	Impedance 120Ω connecting line is recommended.

Engine type: MTU-MDEC-303

15.12 MTU ADEC(SMART MODULE)

It is suitable for MTU engine with ADEC (ECU8) and SMART module.

Terminals of controller	ADEC (X1port)	Remark
Fuel relay output	X1 10	X1 Terminal 9 Connected to negative of battery
Start relay output	X1 34	X1 Terminal 33 Connected to negative of battery

Terminals of controller	SMART (X4 port)	Remark
CAN GND	X4 3	CAN communication shielding line(connect with controller at controller's side only)
CAN(H)	X4 1	Impedance 120Ω connecting line is recommended.
CAN(L)	X4 2	Impedance 120Ω connecting line is recommended.

Engine type: MTU-ADEC

15.13 MTU ADEC(SAM MODULE)

It is suitable for MTU engine with ADEC (ECU7) and SAM module.

Terminals of controller	ADEC (X1port)	Remark
Fuel relay output	X1 43	X1 Terminal 28 Connected to negative of battery
Start relay output	X1 37	X1 Terminal 22 Connected to negative of battery

Terminals of controller	SAM (X23 port)	Remark
CAN GND	X23 3	CAN communication shielding line(connect with controller at controller's side only)
CAN(H)	X23 2	Impedance 120Ω connecting line is recommended.
CAN(L)	X23 1	Impedance 120Ω connecting line is recommended.

Engine type: Common J1939

15.14 PERKINS

It is suitable for ADEM3/ ADEM4 engine control module. Engine type is 2306, 2506, 1106, and 2806.

Terminals of controller	Connector	Remark
Fuel relay output	1,10,15,33,34	
Start relay output	-	Connect to starter coil directly
CAN GND	-	CAN communication shielding line(connect with controller at controller's side only)
CAN(H)	31	Impedance 120Ω connecting line is recommended.
CAN(L)	32	Impedance 120Ω connecting line is recommended.

Engine type: Perkins

15.15 SCANIA

It is suitable for S6 engine control module. Engine type is DC9, DC12, and DC16.

Terminals of controller	B1 connector	Remark
Fuel relay output	3	
Start relay output	-	Connect to starter coil directly
CAN GND	-	CAN communication shielding line(connect with controller at controller's side only)
CAN(H)	9	Impedance 120Ω connecting line is recommended.
CAN(L)	10	Impedance 120Ω connecting line is recommended.

Engine type: Scania

15.16 VOLVO EDC3

Suitable engine control mode is TAD1240, TAD1241, and TAD1242.

Terminals of controller	"Stand alone" connector	Remark
Fuel relay output	H	
Start relay output	E	
programmable output 1	P	ECU power Set configurable output 1as "ECU power".

Terminals of controller	"Data bus" connector	Remark
CAN GND	-	CAN communication shielding line(connect with controller at controller's side only)
CAN(H)	1	Impedance 120Ω connecting line is recommended.
CAN(L)	2	Impedance 120Ω connecting line is recommended.

Engine type: Volvo

▲NOTE: When this engine type is selected, preheat time should be set more than 3 seconds.

15.17 VOLVO EDC4

Suitable engine types are TD520, TAD520 (optional), TD720, TAD720 (optional), TAD721, TAD722, and TAD732.

Terminals of controller	Connector	Remark
Fuel relay output	Expanded 30A relay; battery voltage of terminal 14 is supplied by relay. Fuse is 16A	
Start relay output	-	Connect to starter coil directly
	1	Connected to negative of battery
CAN GND	-	CAN communication shielding line(connect with controller at controller's side only)
CAN(H)	12	Impedance 120Ω connecting line is recommended.
CAN(L)	13	Impedance 120Ω connecting line is recommended.

Engine type: VolvoEDC4

15.18 VOLVO-EMS2

Volvo Engine types are TAD734, TAD940, TAD941, TAD1640, TAD1641, and TAD1642.

Terminals of controller	Engine's CAN port	Remark
Configurable output 1	6	ECU stop Set configurable output 1 as "ECU stop"
Configurable output 2	5	ECU power Set configurable output 1 as "ECU power"
	3	Negative power
	4	Positive power
CAN GND	-	CAN communication shielding line(connect with controller at controller's side only)
CAN(H)	1(Hi)	Impedance 120Ω connecting line is recommended.
CAN(L)	2(Lo)	Impedance 120Ω connecting line is recommended.

Engine type: Volvo-EMS2

▲NOTE: When this engine type is selected, preheating time should be set more than 3 seconds.

15.19 YUCHAI

It is suitable for BOSCH common rail pump engine.

Terminals of controller	Engine 42 pins port	Remark
Fuel relay output	1.40	Connect to engine ignition lock
Start relay output	-	Connect to starter coil directly
CAN GND	-	CAN communication shielding line(connect with controller at controller's side only)
CAN(H)	1.35	Impedance 120Ω connecting line is recommended.
CAN(L)	1.34	Impedance 120Ω connecting line is recommended.

Battery	Engine 2 pins port	Remark
Battery negative	1	Wire diameter 2.5mm ²
Battery positive	2	Wire diameter 2.5mm ²

Engine type: BOSCH

15.20 WEICHAI

It is suitable for Weichai BOSCH common rail pump engine.

Terminals of controller	Engine port	Remark
Fuel relay output	1.40	Connect to engine ignition lock
Start relay output	1.61	
CAN GND	-	CAN communication shielding line(connect with controller at controller's side only)
CAN(H)	1.35	Impedance 120Ω connecting line is recommended.
CAN(L)	1.34	Impedance 120Ω connecting line is recommended.

Engine type: GTSC1

▲NOTE: If there is any question about communication between controller and ECU, please feel free to contact Smartgen's service.

16 USB

Users can set the controller's parameters and monitor the controller's status via the test software which provided by Smartgen company. The connection way between PC and controller as following:



17 FAULT FINDING

Symptoms	Possible Solutions
Controller no response with power.	Check starting batteries; Check controller connection wirings; Check DC fuse.
Genset shutdown	Check the water/cylinder temperature is too high or not; Check the genset AC voltage; Check DC fuse.
Controller emergency stop	Check emergence stop button is correct or not; Check whether the starting battery positive be connected with the emergency stop input; Check whether the circuit is open.
Low oil pressure alarm after crank disconnect	Check the oil pressure sensor and its connections.
High water temperature alarm after crank disconnect	Check the temperature sensor and its connections.
Shutdown Alarm in running	Check related switch and its connections according to the information on LCD; Check programmable input ports.
Start Failure	Check fuel circuit and its connections; Check starting batteries; Check speed sensor and its connections; Refer to engine manual.
Starter no response	Check starter connections; Check starting batteries.
Genset running while ATS not transfer	Check ATS; Check the connections between ATS and controllers.
RS485 communication is abnormal	Check connections; Check the setting of COM port is correct or not; Check RS485's connections of A and B is reverse connect or not; Check RS485 transfer model whether damage or not; Check communication port of PC whether damage or not.
ECU communication failed	Check connections of CAN high and low polarity; Check if correctly connected of 120Ω resistor; Check if engine type is correct; Check if connections from controller to engine and setting of outputs are correct.
ECU warning or stop	Get information from LCD of alarm page; If there is detailed alarm, check engine according to description. If not, please refer to engine manual according to SPN alarm code.