



SmartGen
ideas for power

HAT832

THREE POWER ATS CONTROLLER (DUAL-ATS)

USER MANUAL



SMARTGEN (ZHENGZHOU) TECHNOLOGY CO., LTD.

CONTENT

CONTENT	3
1 OVERVIEW	5
2 PERFORMANCE AND CHARACTERISTICS	6
3 SPECIFICATION	8
4 MEASURE AND DISPLAY DATA	9
5 OPERATION.....	10
5.1 INDICATORS.....	10
5.2 KEY FUNCTION DESCRIPTION.....	11
6 LCD DISPLAY	12
6.1 MAIN SCREEN.....	12
6.2 STATUS DESCRIPTION	13
6.1 MAIN MENU	18
7 START/STOP OPERATION	19
7.1 MANUAL START/STOP.....	19
7.2 AUTO START/STOP.....	21
8 PARAMETERS CONFIGURATION.....	26
8.1 ILLUSTRATION	26
8.2 PARAMETERS TABLE	26
8.3 DIGITAL INPUT/OUTPUT FUNCTION DESCRIPTION.....	36
8.4 DEFINITE TIME DELAY AND INVERSE DEFINITE MINIMUM TIME SETTING	43
9 HISTORICAL RECORDS.....	44
10 BLACK BOX RECORDS	45
11 SWITCH OPERATION	46
11.1 MANUAL OPERATION	46
11.2 AUTOMATIC OPERATION	47
12 ATS POWER SUPPLY	48
13 NEL CONTROL.....	49
13.1 ILLUSTRATION	49
13.2 AUTO OPERATION	49
13.3 MANUAL OPERATION.....	49
14 COMMUNICATION CONFIGURATION	50
15 TERMINALS	51
16 TYPICAL WIRING DIAGRAM.....	55



17 INSTALLATION60
18 TROUBLE SHOOTING61

SmartGen

1 OVERVIEW

HAT832 Three Power ATS controller (Dual-ATS) is intelligent tri-supply module with configurable function, automatic measurement, LCD display, and digital communication. It combines digitization, intelligence and networking. Automatic measurement and control can reduce incorrect operation, which is an ideal option for ATS.

The powerful Microprocessor contained within the unit allows for precision voltage (3-way 3-phase) measuring and make accurate judgment and the corresponding volt free digital output port will active when there is over/under voltage, over/under frequency, loss of phase, phase sequence wrong and other abnormal condition occurs. It has compact structure, advanced circuits, simple wiring and high reliability, and can be widely used in electric device and automatic control system of electric power, telecommunications, petroleum, coal, metallurgy, railways, municipal administration, intelligent building, etc.

SmartGen

2 PERFORMANCE AND CHARACTERISTICS

- System type can set as: Mains-Gen-Mains, Gen-Mains-Mains, Mains-Mains-Mains, Gen-Gen-Mains, Mains-Gen-Gen, Gen-Mains-Gen, and Mains-Mains-Gen;
- 4.3 inches solid color 240x128 LCD display with white backlight, multilingual interface (including English, Simplified Chinese, Other), push-button operation;
- Collect and display 3-way 3-phase voltage, frequency and phase sequence;
- Collect and display load active power, reactive power, apparent power, power factor and current;
- S1/S2/S3 separated over current warning/ trip alarm;
- NEL (Non-essential Load) trip function;
- Display S1/S2/S3 total kW energy, total kvar energy, total close times;
- Display continuous power supply time and S1/S2/S3 total power supply time;
- For Stored-Energy type ATS, its close relay will active after the PF Input is active;
- Over/under voltage, over/under frequency, over current, loss of phase, phase sequence wrong protection;
- Automatic/Manual mode. In manual mode, can force the switch to close or open;
- All parameters can be set on site. Passwords authentication ensures authorized staff operation only;
- The genset can be manual test on site to achieve start/stop operation;
- Automatic re-closing;
- Closing output signal can be set as on intervals or as continuous output;
- Applicable for 3 isolated neutral line;
- Real-time clock (RTC); event log function (event log can record 200 items circularly);
- Black box function, which can cycle record 5 pieces of log and each log contains 60 groups of data including breaker state detailed data of 50s before and 10s after switchover;
- Scheduled routing run & scheduled not run (can be set as start genset once a day/week/month whether with load or not);
- Can control two generators to work as cycle run mode, master run mode and balance run mode;
- Widely DC power supply range allows the controller can bear instantaneous 80V DC input;
- Large terminal space allows the controller can bear maximum 625V AC voltage input;
- With Dual-RS485 isolated communication interface. With "remote controlling, remote measuring, remote communication, remote regulating" function by the ModBus-RTU communication protocol. Can remote start/stop the genset and remote control the breaker to close or open;
- Suitable for various AC systems (3-phase 4-wire, 3-phase 3-wire, single-phase 2-wire, and



2-phase 3-wire);

- Modular design, self extinguishing ABS plastic shell, pluggable terminal, built-in mounting, compact structure with easy installation.

SmartGen

3 SPECIFICATION

Table 2 – Performance Parameters

Items	Contents	
Operating Voltage	1. DC8.0V~35.0V, continuous power supply 2. AC(90~305)V power supply A1N1/A2N2/A3N3	
Power Consumption	<7W(Standby mode:≤2W)	
AC Voltage Input	AC system	
	3P4W (L-L)	(80~530)V
	3P3W (L-L)	(80~625)V (DC supply)
	1P2W (L-N)	(50~305)V
	2P3W (A-B)	(80~530)V
Rated Frequency	50/60Hz	
Programmable Output 1~6 Relay Capacity	16A AC250V Volts free output	
Programmable Output 7~12 Relay Capacity	8A AC250V Volts free output	
ATS Power Supply Relay Capacity	16A AC250V Volts free output	
Digital Input	GND (B-) connect is active.	
Communication	1. Dual-RS485 isolated interface, MODBUS Protocol 2. D-type USB port	
Case Dimensions	260mmx180mmx54mm	
Panel Cutout	242mmx161mm	
Working Conditions	Temperature: (-25~+70)°C; Relative Humidity: (20~93)%RH	
Storage Condition	Temperature: (-25~+70)°C	
Protection Level	IP65: when water proof gasket ring inserted between panel and housing.	
Insulation Strength	Apply AC1.5kV voltage between high voltage terminal and low voltage terminal; The leakage current is not more than 3mA within 1min.	
Weight	1.2kg	

4 MEASURE AND DISPLAY DATA

Table 3 – Display Parameters

No.	Measure & Display Data Items
1	S1/S2/S3 Power Phase Voltage
2	S1/S2/S3 Power Line Voltage
3	S1/S2/S3 Power Phase
4	S1/S2/S3 Power Frequency
5	Load 3-Phase Current
6	Load 3-Phase Active Power kW
7	Load Total Active Power kW
8	Load 3-Phase Reactive Power kvar
9	Load Total Reactive Power kvar
10	Load 3-Phase Apparent Power kVA
11	Load Total Apparent Power kVA
12	Load 3-Phase Power Factor PF
13	Load Average Power Factor PF
14	Continuous Power Supply Time (Currently)
15	Continuous Power Supply Time (Last Time)
16	S1 Total Power Supply Time
17	S2 Total Power Supply Time
18	S3 Total Power Supply Time
19	S1 Total kW Energy kWh
20	S2 Total kW Energy kWh
21	S3 Total kW Energy kWh
22	S1 Total kvar Energy kvarh
23	S2 Total kvar Energy kvarh
24	S3 Total kvar Energy kvarh
25	QS1 Total Close Times
26	QS2 Total Close Times
27	QS3 Total Close Times
28	QS12 Total Close Times
29	Input/Output Port Status
30	Real Time Clock
31	Alarm Status
32	Communication Status

5 OPERATION



Fig.1 – Penal Indication Drawing













5.1 INDICATORS

Table 4 – Indicators Description

Indicator Type	Description
Alarm	Slow flashing (1time per sec) when warn alarm occurs. Fast flashing (5 times per sec) when fault alarm occurs.
Man	Light on when the module is in Manual mode.
Auto	Light on when the module is in Auto mode.
Alarm Mute	Light on when alarm mute.
IOO	Illuminated: QS1, QS2closed, S1 supply power for load. Flashing: status switching
OIO	Illuminated: QS2, QS12 closed, S2 supply power for load. Flashing: status switching
OOI	Illuminated: QS3 closed, S3 supply power for load. Flashing: status switching
OOO	Illuminated: QS1, QS2, QS12, QS3 all open, offload. Flashing: status switching
Genset	Light on when the Start signal is be initiated.

5.2 KEY FUNCTION DESCRIPTION







Table 5 – Buttons Function Description



Icon	Buttons	Function Description
	I00	Active in Manual mode. QS1, QS12 close and S1 supply after pressing this key.
	O10	Active in Manual mode. QS2, QS12 close and S2 supply after pressing this key.
	O01	Active in Manual mode. QS3 close and S3 supply after pressing this key.
	O00	Active in Manual mode. Offload after pressing this key.
	Test	Press this key to enter to genset manual start/stop operation interface.
	Alarm Mute	Press this key to enter into alarm page and mute the alarm.
	Man/Auto	Manual mode and Auto mode switching.
	Alarm Reset	Pressing this key can reset fault alarm.
	Return/Homepage	When setting parameters, press the key to return back. In main screen, press the key to return the first screen; in other screen, press the key to return to main screen.
	Set/Confirm	In main screen, press the key to enter to menu. In menu screen, press this key can move cursor and confirm setting information.
	Up	In main screen, press the key to scroll up screen. In menu interface, press this key to up cursor or increase value in setting menu.
	Down/Lamp Test	In main screen, press the key to scroll down screen. In menu interface, press this key to down cursor or decrease value in setting menu. In main screen, press the key for seconds to enter lamp test mode, LCD backlit and all LED lamps are lit and LCD screen display black.

6 LCD DISPLAY

6.1 MAIN SCREEN

Table 6 – Screen Display

Items	Display Contents
Homepage	<p>S1 status, S2 status, S3 status, switch status, generator start status;</p> <p>Supply system diagram, QS1 is side switch for S1, QS2 is side switch for S2, QS12 is side switch for S1 and S2, QS3 is side switch for S3;</p> <p>S1/S2/S3 voltage and frequency;</p> <p>S1/S2/S3 priority switch;</p> <p>Total active power, maximum loading current.</p> <p>AutoTrans/Restore status.</p>
S1 S2 S3	<p>S1 line voltage, phase voltage and frequency, phase angle;</p> <p>S2 line voltage, phase voltage and frequency, phase angle;</p> <p>S3 line voltage, phase voltage and frequency, phase angle.</p>
Load 	<p>3-phase current (I1,I2,I3);</p> <p>Active Power kW (Sum of P1, P2, P3);</p> <p>3-Phase Reactive Power (sum of Q1,Q2,Q3);</p> <p>3-Phase Apparent Power kVA(sum of S1,S2,S3);</p> <p>3-Phase Average Power Factor PF(average of PF1,PF2,PF3).</p>
CUM. 	<p>3-Phase total active energy and total reactive energy.</p>
TIME 	<p>Current continuous power supply time;</p> <p>Last time continuous power supply time.</p>
CUM. 	<p>S1 total power supply time;</p> <p>S2 total power supply time;</p> <p>S3 total power supply time.</p>
QF 	<p>QS1 Total Close Times;</p> <p>QS2 Total Close Times;</p> <p>QS12 Total Close Times;</p> <p>QS3 Total Close Times;</p>
I/O 	<p>Programmable digital input status and auxiliary status;</p> <p>Programmable digital output status.</p>
Comm.	<p>RS485-1 Comm. status and baud rate;</p>

Items	Display Contents
	RS485-2 Comm. status and baud rate; USB Comm. status.
Alarms 	Present alarm informations (warn alarm and fault alarm)
Status	Alarm status/working status; Real-time clock; Status line is showed below in every main screen pages.

6.2 STATUS DESCRIPTION

Table 7 – S1 Voltage Status

No.	Item	Description
1	S1 Available	S1 normal delay
2	S1 Unavailable	S1 abnormal delay
3	S1 Available	Power supply voltage is within the setting range
4	S1 Blackout	Voltage is 0
5	S1 Over Volt	Voltage is higher than the set value
6	S1 Under Volt	Voltage has fallen below the set value
7	S1 Over Freq	Frequency is higher than the set value
8	S1 Under Freq	Frequency has fallen below the set value
9	S1 Loss of Phase	Loss of any phase of A, B and C
10	S1 Phase Seq Wrong	A-B-C phase sequence is wrong

Table 8 – S2 Voltage Status

No.	Item	Description
1	S2 Available	S2 normal delay.
2	S2 Unavailable	S2 abnormal delay.
3	S2 Available	Power supply voltage is within the setting range.
4	S2 Blackout	Voltage is 0.
5	S2 Over Volt	Voltage is higher than the set value.
6	S2 Under Volt	Voltage has fallen below the set value.
7	S2 Over Freq	Frequency is higher than the set value.
8	S2 Under Freq	Frequency has fallen below the set value.
9	S2 Loss of Phase	Loss of any phase of A, B and C.
10	S2 Phase Seq Wrong	A-B-C phase sequence is wrong.

Table 9 – S3 Voltage Status

No.	Item	Description
1	S3 Available	S3 normal delay
2	S3 Unavailable	S3 abnormal delay
3	S3 Available	Power supply voltage is within the setting range.
4	S3 Blackout	Voltage is 0.
5	S3 Over Volt	Voltage is higher than the set value.
6	S3 Under Volt	Voltage has fallen below the set value.
7	S3 Over Freq	Frequency is higher than the set value.
8	S3 Under Freq	Frequency has fallen below the set value.
9	S3 Loss of Phase	Loss of any phase of A, B and C.
10	S3 Phase Seq Wrong	A-B-C phase sequence is wrong.

Table 10 – Genset Status

No.	Item	Description
1	Start Delay	Delay time before genset start
2	Return Delay	Delay time before genset stop
3	Scheduled Not Work	When scheduled not run is active, its duration time will be displayed.
4	Scheduled Work	When scheduled run is active, its duration time will be displayed.
5	S1 Cycle Run	S1 cycle run countdown will be terminated when cycle start is active.
6	S2 Cycle Run	S2 cycle run countdown will be terminated when cycle start is active.
7	S3 Cycle Run	S3 cycle run countdown will be terminated when cycle start is active.
8	S1 Genset Working	Active only when system has 2 gensets and S1 generating.
9	S2 Genset Working	Active only when system has 2 gensets and S2 generating.
10	S3 Genset Working	Active only when system has 2 gensets and S3 generating.
11	Genset Working	Genset start signal output.
12	Genset Standby	There is no start genset signal output.

Table 11 – Switch Status

No.	Item	Description
1	Ready to Transfer	Switch transfer begins.
2	QS1 Closing	QS1 closing delay is in progress.
3	QS1 Opening	QS1 opening delay is in progress.
4	QS2 Closing	QS2 closing delay is in progress.
5	QS2 Opening	QS2 opening delay is in progress.
6	QS12 Closing	QS12 closing delay is in progress.
7	QS12 Opening	QS12 opening delay is in progress.
8	QS3 Closing	QS3 closing delay is in progress.
9	QS3 Opening	QS3 opening delay is in progress.



No.	Item	Description
10	Transfer Rest	Interval time between switch transfer
11	Closing QS1 Again	If "Closing Again Delay" is not 0, when the QS1 "Fail to open" condition occurs, it's the delay time before the close relay is active for the second time.
12	Opening QS1 Again	If "Opening Again Delay" is not 0, when the QS1 "Fail to close" condition occurs, it's the delay time before the close relay is active for the second time.
13	Closing QS2 Again	If "Closing Again Delay" is not 0, when the QS2 "Fail to open" condition occurs, it's the delay time before the close relay is active for the second time.
14	Opening QS2 Again	If "Opening Again Delay" is not 0, when the QS2 "Fail to close" condition occurs, it's the delay time before the close relay is active for the second time.
15	Closing QS12 Again	If "Closing Again Delay" is not 0, when the QS12 "Fail to open" condition occurs, it's the delay time before the close relay is active for the second time.
16	Opening QS12 Again	If "Opening Again Delay" is not 0, when the QS12 "Fail to close" condition occurs, it's the delay time before the close relay is active for the second time.
17	Closing QS3 Again	If "Closing Again Delay" is not 0, when the QS3 "Fail to open" condition occurs, it's the delay time before the close relay is active for the second time.
18	Opening QS3 Again	If "Opening Again Delay" is not 0, when the QS3 "Fail to close" condition occurs, it's the delay time before the close relay is active for the second time.
19	Waiting QS1 PF	Before QS1 is closed, it's the delay time to confirm "QS1 PF Input" signal is active.
20	Waiting QS2 PF	Before QS2 is closed, it's the delay time to confirm "QS2 PF Input" signal is active.
21	Waiting QS12 PF	Before QS12 is closed, it's the delay time to confirm "QS2 PF Input" signal is active.
22	Waiting QS3 PF	Before QS3 is closed, it's the delay time to confirm "QS3 PF Input" signal is active.
23	Elevator Delay	Elevator control output before ATS transfer.
24	S1 On Load	QS1, QS2 were already closed and S1 is taking load.
25	S2 On Load	QS2, QS12 were already closed and S2 is taking load.
26	S3 On Load	QS3 was already closed and S3 is taking load.
27	Offload	Switch was already opened and load is disconnected.

Warning alarms are active when controller detects the alarm signals, and alarm indicator will flash slowly (1time per sec). When alarm is reset, indicator is extinguished, which means warn alarms are not latched.

Table 12 – Warning Alarms

No.	Item	Description
1	S1 Over Current Warn	When the S1 current has exceeded the pre-set value and the action select “Warn”, it will initiate a warning alarm.
2	S2 Over Current Warn	When the S2 current has exceeded the pre-set value and the action select “Warn”, it will initiate a warning alarm.
3	S3 Over Current Warn	When the S3 current has exceeded the pre-set value and the action select “Warn”, it will initiate a warning alarm.
4	Forced Open Warn	When the input is active and the action (cut off non-fire supply) select “Warn”, it will initiate a warning alarm.
5	Battery Under Volt	When the battery voltage has fallen below the pre-set value, it will initiate a warning alarm.
6	Battery Over Volt	When the battery voltage has exceeded the pre-set value, it will initiate a warning alarm.

Fault alarms are active when controller detects the alarm signals. Alarm indicator will flash rapidly (5 times per sec) and the alarm will last until it was removed manually. Fault alarms are latched.

Table 13 – Fault Aalrms

No.	Item	Description
1	QS1 Failed to Close	QS1 fail to close.
2	QS1 Failed to Open	QS1 fail to open.
3	QS2 Failed to Close	QS2 fail to close.
4	QS2 Failed to Open	QS2 fail to open.
5	QS12 Failed to Close	QS12 fail to close.
6	QS12 Failed to Open	QS12 fail to open.
7	QS3 Failed to Close	QS3 fail to close.
8	QS3 Failed to Open	QS3 fail to open.
9	S1 Over Current Trip	When the S1 is taking load and its current has exceeded the pre-set value, and the action select “Trip”, it will initiate a trip alarm.
10	S2 Over Current Trip	When the S2 is taking load and its current has exceeded the pre-set value and the action select “Trip”, it will initiate a trip alarm.
11	S3 Over Current Trip	When the S3 is taking load and its current has exceeded the pre-set value and the action select “Trip”, it will initiate a trip alarm.
12	Forced Open Fault	When the input is active and the action (cut off non-fire supply) select “Fault”, it will initiate a fault alarm.
13	S1 Genset Fault	Only when system has 2 gensets and S1 generating, S1 fail to start.



No.	Item	Description
14	S2 Genset Fault	Only when system has 2 gensets and S2 generating, S2 fail to start.
15	S3 Genset Fault	Only when system has 2 gensets and S3 generating, S3 fail to start.
16	Switch Trip Alarm	It will initiate a fault alarm, when the input is active.

The indication information will continuously display for 2s after it is active.

Table 14 – Indication Information

No.	Item	Description
1	Please Reset The Alarm	When there is fault alarm occurs, the indication will be displayed when change the genset mode to Auto Mode manually.
2	S1 Already Closed.	After S1 was already closed, the indication will be displayed when “S1 close (IOO)” button is pressed.
3	S2 Already Closed.	After S2 was already closed, the indication will be displayed when “S2 close (OIO)” button is pressed.
4	S3 Already Closed.	After S3 was already closed, the indication will be displayed when “S3 close (OOI)” button is pressed.
5	Already Openned	While in breaker opening status, the indication will be displayed when “Open (OOO)” button is pressed.
6	Panel Locked	The information displays when panel lock is active and keys are pressed (Manual/Auto, Alarm Reset, Alarm Mute, IOO, OIO, OOI, OOO and Genset keys).
7	AC System Abnormal	After pressed close S1(IOO), S2(OIO), and S3(OOI), the indication will be displayed when power supply is fault and AC system is disable to transfer.

Table 15 – Other Status Information

No.	Item	Description
1	Start Inhibit	Genset start Inhibit is active.
2	S1 Load Inhibit	S1 Load Inhibit input is active.
3	S2 Load Inhibit	S2 Load Inhibit input is active.
4	S3 Load Inhibit	S3 Load Inhibit input is active.
5	NEL 1 Trip	NEL1 off load signal is output.
6	NEL2 Trip	NEL2 off load signal is output.
7	NEL3 Trip	NEL3 off load signal is output.
8	Remote Gen On Load	Remote start (on load) signal is active.
9	Remote Gen Off Load	Remote start (off load) signal is active.
10	Gen Start Mains NG	Start genset when mains is abnormal.
11	Gen Start Master	Start when the gens supply and switching to highest priority.



No.	Item	Description
12	Auto Mode	Current mode is Auto mode.
13	Manual Mode	Current mode is Manual mode.

6.3 MAIN MENU

In main screen, press  key will enter into the menu interface.

<ul style="list-style-type: none"> 1. Configuration 2. Data Calibration 3. Historical Records 4. Black Box Records 5. AutoCharge/Recover 6. Language 7. About 	<p>Press Up/Down key to choose parameters (the current line was highlighted with black) and then press Confirm key to enter into the corresponding display screen.</p>
--	--

▲NOTE: Default password is 01234, user can change it in case of others change the parameters setting. Please clearly remember the password after changing. If you forget it, please contact SmartGen services.

▲NOTE: Data Calibration is for factory use only and correct passwords must be input before entered.

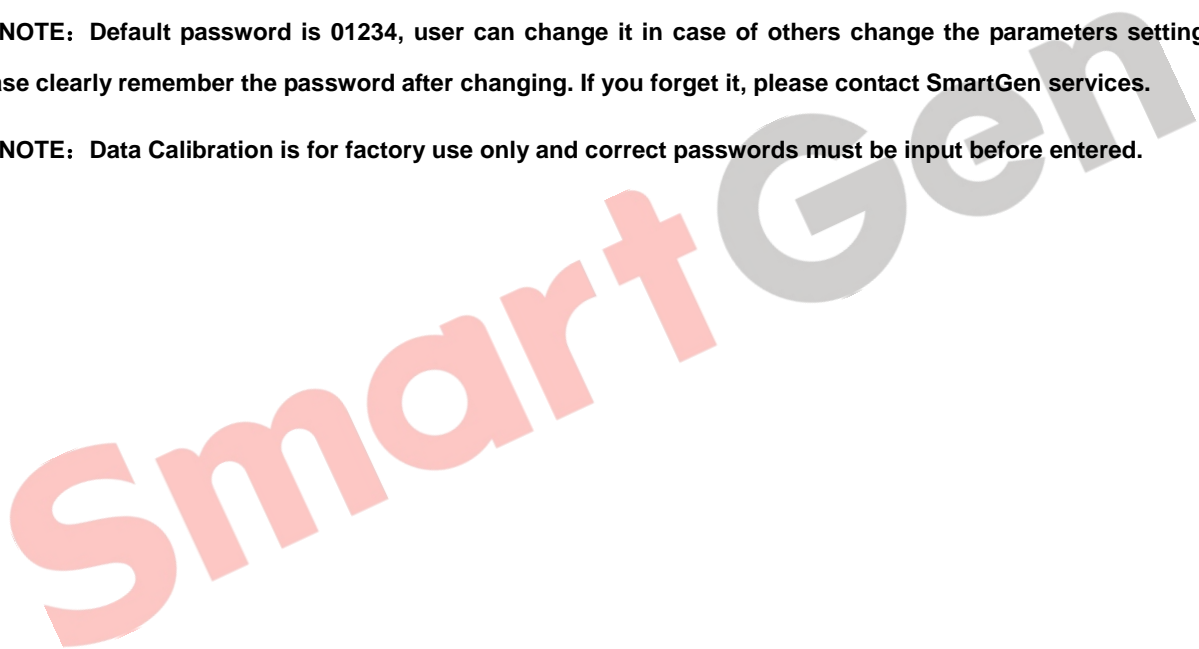

7 GENSET OPERATION

7.1 MANUAL START/STOP

7.1.1 PANEL START/STOP

In the main screen, according to different system types, press  key to enter to different start/stop menu screens.

7.1.1.1 SYSTEM TYPE “S1 GEN S2 GEN S3 MAINS”

When system type is “S1 Gen S2 Gen S3 Mains”, manual start/stop interface is as below:

Manual Start Genset	<p>Press “Up/Down” key to choose parameters (the current line was highlighted with black) and then press “Confirm” key to confirm.</p>
Return	
S1 Genset Stop	
S1 Genset Start	
S2 Genset Stop	
S2 Genset Start	

S1 Genset Stop: Disconnect the start signal of S1 genset, i.e. stop the running S1 genset.

S1 Genset Start: Output the start signal of S1, i.e. start the S1 genset.

S2 Genset Stop: Disconnect the start signal of S2 genset, i.e. stop the running S2 genset.

S2 Genset Start: Output the start signal of S2, i.e. start the S2 genset.

7.1.1.2 SYSTEM TYPE “S1 GEN S2 MAINS S3 GEN”

When system is “S1 Gen S2 Mains S3 Gen”, manual start/stop menu interface is as below:

Manual Start Genset	<p>Press “Up/Down” key to choose parameters (the current line was highlighted with black) and then press “Confirm” key to confirm.</p>
Return	
S1 Genset Stop	
S1 Genset Start	
S3 Genset Stop	
S3 Genset Start	

S1 Genset Stop: Disconnect the start signal of S1 genset, i.e. stop the running S1 genset.

S1 Genset Start: Output the start signal of S1, i.e. start the S1 genset.

S3 Genset Stop: Disconnect the start signal of S3 genset, i.e. stop the running S3 genset.

S3 Genset Start: Output the start signal of S3, i.e. start the S3 genset.

7.1.1.3 SYSTEM TYPE “S1 MAINS S2 GEN S3 GEN”

When system is “S1 Mains S2 Gen S3 Gen”, manual start/stop menu interface is as below:

Manual Start Genset	Press “Up/Down” key to choose parameters (the current line was highlighted with black) and then press “Confirm” key to confirm.
Return	
S2 Genset Stop	
S2 Genset Start	
S3 Genset Stop	
S3 Genset Start	

S2 Genset Stop: Disconnect the start signal of S2 genset, i.e. stop the running S2 genset.

S2 Genset Start: Output the start signal of S2, i.e. start the S2 genset.

S3 Genset Stop: Disconnect the start signal of S3 genset, i.e. stop the running S3 genset.

S3 Genset Start: Output the start signal of S3, i.e. start the S3 genset.

7.1.1.4 OTHER SYSTEM TYPE

When system is “S1 Mains S2 Gen S3 Mains”, “S1 Gen S2 Mains S3 Mains”, “S1 Mains S2 Mains S3 Gen”, manual start/stop menu interface is as below:

Manual Start Genset	Press “Up/Down” key to choose parameters (the current line was highlighted with black) and then press “Confirm” key to confirm.
Return	
Genset Stop	
Genset Start	

Genset Stop: Disconnect the start signal of genset, i.e. stop the running genset.

Genset Start: Output the start signal of genset, i.e. start the genset.

7.1.2 REMOTE START/STOP

Send remote start/stop signals using MODBUS protocol via RS485 port.

Remote Stop: Disconnect the start signal, i.e. stop the running genset.

Remote Start: Output the start signal, i.e. start the genset.

7.2 AUTO START/STOP

7.2.1 START/STOP FOR ONE GENSET

When system type is “S1 Gen S2 Mains S3 Mains”, “S1 Mains S2 Gen S3 Mains”, or “S1 Mains S2 Mains S3 Gen”, configure input port as “Remote Start On Load” or “Remote Start Off Load”, both could not be set simultaneously.

Remote Start on Load: When the input is active, genset close relay will active after genset is normal; when the input inactive, genset will stop automatically.

Remote Start off Load: When the input is active, mains close relay will active after mains is normal; when the input inactive, genset will stop automatically.

Gen Start Mains NG: If one of the mains is the highest priority of the system, the genset is the secondary priority, when mains fault, genset starts output; or both two ways of mains fault, genset starts output.

Gen Start Master: If genset is the highest priority of the system, genset starts output; genset is available and “Auto Charge/Recover” is enabled, breaker will transfer to gen to take on load.

7.2.2 START/STOP FOR TWO GENSETS

When system type is “S1 Gens S2 Gen S3 Mains”, S1, S2 start/stop; when system is “S1 Gen S2 Mains S3 Gen”, S1, S3 start/stop; when system is “S1 Mains S2 Gen S3 Gen”, S2, S3 start/stop.

7.2.2.1 START CONDITIONS

Gen Start Mains NG: when mains is abnormal, S1 or S2 or S3 (determined by start priority) start to supply. Genset close relay will active after genset is normal.

Remote Start on Load: Detect S1 or S2 or S3 start output according to start priority and start mode. Genset close relay will active after genset is normal.

Remote Start off Load: Detect S1 or S2 or S3 start output according to start priority and start mode. Genset S1 close relay, S2 close relay and S3 close relay are deactivated after genset start.

Scheduled Run: After “Scheduled Run” function is enabled, users can set start genset time, when the time is arrive, controller initiates start signal, and when the duration time of scheduled run is expired, start signal will be disconnected.

7.2.2.2 START MODE

Start mode for two gensets is including: “Cycle Run Start”, “Master Run Start”, “Balance Run Start” and “Not Used”.

When start condition is active, genset will start/stop according to selected start mode.

Cycle Run Start:

If system is “S1 Gen S2 Gen S3 Mains”, when S3 Mains is abnormal or remote start/scheduled start is active, S1 and S2 cycle run start according to the cycle run time. At the first time to start the genset, choose “S1 Start” or “S2 Start” depends on “Priority”. e.g. S1 start firstly if “S1” has higher

priority. Then S1 cycle run countdown is started according to the preset delay. At the same time, genset fault detect delay will be initiated. If S1 genset is normal before the fault delay has expired, S1 will take load; S2 start after the preset S1 cycle run delay has expired and the S2 loading process is same as S1. S1 will stop automatically after the S2 has take load successfully. S1 and S2 will cycle run in this way alternately until the remote start signal deactivated.

During the start process, if there is genset fault alarm (genset supply delay overtime or genset fault input is active), fail to close or load inhibit alarm occurs, the starting genset will be stop immediately and the additional genset will be start automatically.

If change the operation mode to MANUAL in cycle run process, running status of genset will not change but cycle running timing will be stopped.

Flow diagram of cycle run is as below,

Note: system type is “S1 Mains S2 Gen S3 Gen” and priority is S1>S2>S3.

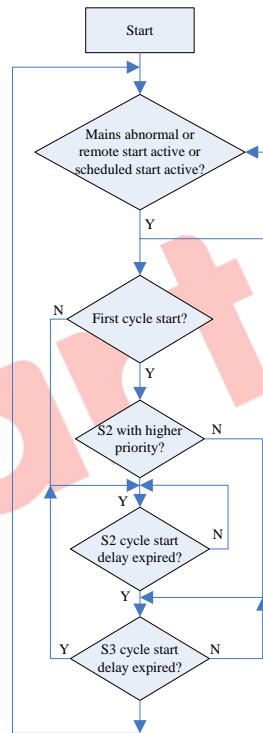

Fig.2 – Cycle Start Flow Diagram

Master Run Start

Master genset will be start when mains abnormal or remote start signal/scheduled start is active. During the start process, if there is genset fault alarm (genset supply delay overtime or genset fault input is active), fail to close or load inhibit alarm occurs, the starting genset will be stop immediately and the additional genset will be start automatically. Otherwise, the master run genset will running continuously until the remote start signal deactivated or mains back to normal or scheduled start duration time is up.

Flow diagram of master run start is as below,

Note: system type is “S1 Mains S2 Gen S3 Gen” and priority is S1>S2>S3.

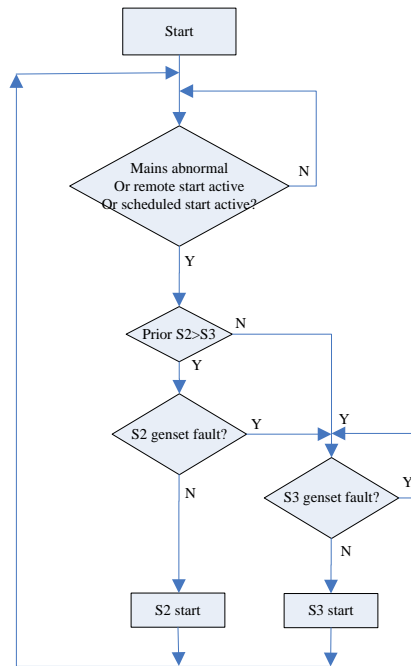

Fig.3 – Master Run Start Flow Diagram

Balance Run Start

The gensets which has the shortest running hours will be start when mains abnormal or remote start signal/scheduled start is active. During the start process, if there is genset fault alarm (genset supply delay overtime or genset fault input is active), fail to close or load inhibit alarm occurs, the starting genset will be stop immediately and the additional genset will be start automatically. Otherwise, the current genset will running continuously until the remote start signal deactivated.

In system of 2 gensets start/stop operation should meet following several conditions:

- 1) It is active in Auto mode;
- 2) System set as “S1 Gen S2 Gen S3 Mains” or “S1 Gen S2 Mains S3 Gen” or “S1 Mains S2 Gen S3 Gen”;
- 3) If system is “S1 Gen S2 Gen S3 Mains”, the output should be set as “S1 Genset Start” and “S2 Genset Start”; if system is “S1 Gens S2 Mains S3 Gens”, the output should be set as “S1 Genset Start” and “S3 Genset Start”; if system is “S1 Mains S2 Gen S3 Gen”, the output should be set as “S2 Genset Start” and “S3 Genset Start”;
- 4) If system is “S1 Gen S2 Gen S3 Mains”, the input should be set as “S1 Genset Fault Input”, “S2 Genset Fault Input” and “Remote StartOnLoad” or “Remote StartOffLoad”; If system is “S1 Gen S2 Mains S3 Gen”, the input should be set as “S1 Genset Fault Input”, “S3 Genset Fault Input” and “Remote StartOnLoad” or “Remote StartOffLoad”; If system is “S1 Mains S2 Gen S3 Gen”, the input should be set as “S2 Genset Fault Input”, “S3 Genset Fault Input” and “Remote StartOnLoad” or “Remote StartOffLoad”;
- 5) Should set the system as “Gen-Gen Start Mode”;
- 6) Should configure setting “Genset Supply Delay”, If start mode is cycle run, also should set “S1 Cycs Work Time”, “S2 Cycs Work Time” or “S1 Cycs Work Time”, “S3 Cycs Work Time” or “S2 Cycs Work Time”, and “S3 Cycs Work Time”;

Among input ports, “S1 Genset Fault Input”, “S2 Genset Fault Input” and “S3 Genset Fault Input” are selective setting, Genset fault can be judged by “Genset Supply Delay” and there no need to inquire the fault alarm via input port.

When Gen-Gen start type configured as “Not Used”, there is no start genset signals output.

Flow diagram of balance run start is as below,

Note: system type is “S1 Mains S2 Gen S3 Gens” and priority is S1>S2>S3.

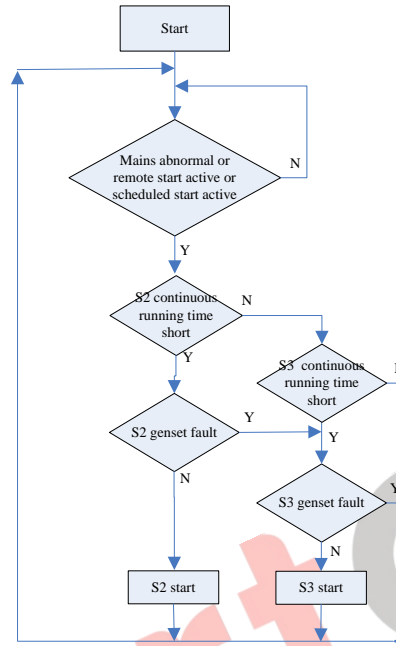

Fig.4 – Balance Run Start Flow Diagram

7.2.3 SCHEDULED RUN

Once “Scheduled Run” enables, users can set the scheduled start time. Controller will send start signal at preset start time. Start signal will deactivated after the scheduled start duration time has expired.

“Scheduled Run On Load” or “Scheduled Run Off Load” can be set.

Scheduled Run On Load: When the input is active, genset close relay will active after genset is normal.

Scheduled Run Off Load: When the input is active, mains close relay will active after mains is normal and gen close relay will active when mains abnormal while gen is normal.

Cycle time of “Scheduled Run” can be set as start monthly, weekly and daily.

Run Monthly: Which month to start, start date and time can be set.

Run Weekly: Can start the genset at the same time in couple days of a week. Eg. Start the genset at 8:00 a.m. from Monday to Friday and keep 10 hours.

Run Daily: Can start the genset at same time everyday.

7.2.4 SCHEDULED NOT RUN

Once "Scheduled Not Run" enables, users can set the "Scheduled Not Start" time. Start signal will deactivated at preset time and start signal will be inhibited before the inhibit start duration time has expired.

Cycle time of "Scheduled Not Run" can be set as monthly, weekly and daily.

Not Run Monthly: Which month not start, not start date and time can be set.

Not Run Weekly: Can not start the genset at the same time in couple days of a week. Eg. Not start the genset at 19:00 p.m. from Monday to Friday and keep 12 hours.



Not Run Daily: Can not start the genset at same time everyday.

 **Note:** "Scheduled Not Run" operation is prior to "Scheduled Run" operation.

SmartGen

8 PARAMETERS CONFIGURATION

8.1 ILLUSTRATION

In the main interface, press /OK key, choose **Configuration** in the manu screen and press  again to enter into password confirmation page. If password is correct, enter into parameter setting page, otherwise, exit to main interface directly. Factory default password is **01234**. In parameters configuration page, pressing  key to return the prior menu.

8.2 PARAMETERS TABLE

Table 16 – Parameter Configuration Form

No.	Item	Range	Default	Description
AC Config				
1	S1 Volt Normal	(0-3600) s	10	The delay from S1 voltage abnormal to normal.
2	S1 Volt Abnormal	(0-3600)s	5	The delay from S1 voltage normal to abnormal.
3	S2 Volt Normal	(0-3600)s	10	The delay from S2 voltage abnormal to normal.
4	S2 Volt Abnormal	(0-3600)s	5	The delay from S2 voltage normal to abnormal.
5	S3 Volt Normal	(0-3600)s	10	The delay from S3 voltage abnormal to normal.
6	S3 Volt Abnormal	(0-3600)s	5	The delay from S3 voltage normal to abnormal.
7	Master Set	(0~5)	0	0: S1>S2>S3 1: S2>S1>S3 2: S3>S1>S2 3: S1>S3>S2 4: S2>S3>S1 5: S3>S2>S1
8	System Type	(0~6)	6	0: S1M S2G S3M 1: S1G S2M S3M 2: S1M S2M S3M 3: S1G S2G S3M 4: S1M S2G S3G 5: S1G S2M S3G 6: S1M S2M S3G
9	AC System	(0~3)	0	0: 3 Phase,4 Wire (3P4W) 1: 3 Phase,3 Wire (3P3W)



No.	Item	Range	Default	Description
				2: 2 Phase,3 Wire (2P3W) 3: Single Phase,2 Wire (1P2W)
10	PT Fitted	(0-1)	0	0: Disable ; 1: Enable
11	PT Primary	(30-30000)V	100	Primary voltage of voltage transformer
12	PT Secondary	(30-1000)V	100	Secondary voltage of voltage transformer
13	Rated Voltage	(0-30000)V	220	Rated voltage of AC system
14	Over Volt Warn	(0-1)	1	0: Disable ; 1: Enable
15	Set Value	(0-200)%	120	Upper limit value of voltage; it is abnormal if the value has exceeded the set value.
16	Return Value	(0-200)%	115	Upper limit return value of voltage; it is normal only when the value has fallen below the set value.
17	Under voltage Warn	(0-1)	1	0: Disable ; 1: Enable
18	Set Value	(0-200)%	80	Lower limit value of voltage; it is abnormal if the value has fallen below the set value.
19	Return Value	(0-200)%	85	Lower limit return value of voltage; it is normal only when the value has exceeded the set value.
20	Rated Frequency	(10.0-75.0)Hz	50.0	Rated frequency of AC system
21	Over Frequency Warn	(0-1)	1	0: Disable ; 1: Enable
22	Set Value	(0-200)%	110	Upper limit value of frequency; it is abnormal if the value has exceeded the set value.
23	Return Value	(0-200)%	104	Upper limit return value of frequency; it is normal only when the value has fallen below the set value.
24	Under Frequency Warn	(0-1)	1	0: Disable ; 1: Enable
25	Set Value	(0-200)%	90	Lower limit value of frequency; it is abnormal if the value has fallen below the set value.
26	Return Value	(0-200)%	96	Lower limit return value of frequency; it is normal only when the value has exceeded the set value.
27	Phase Sequence Wrong	(0-1)	1	0: Disable ; 1: Enable
Switch				
1	Fixed Close/Open Time	(0-1)	0	0: Disable ; 1: Enable Disable: The output time was judged depends on the close relay; the longest output time up to the set delay. Enable: The output time lasts for the preset time.
2	Close Delay	(0.1-20.0)s	5.0	Pulse time of close relay.



No.	Item	Range	Default	Description
3	Open Delay	(0.1-20.0)s	5.0	Pulse time of open relay.
4	Transfer Interval	(1-9999)s	1	Interval time from S1 switch open to S2 switch close; or from S2 switch open to S1 switch close; or S12 switch open to S3 switch close; or S12 switch close to S3 switch open.
5	Auto Charge/Recover	(0-1)	1	0: Auto Charge Man Rec. 1: Auto Charge/Rec.
6	Again Close Delay	(0-20.0)s	0.0	When the breaker fail to open for the first time, then the module will close for the second time and the "Again Close Delay" begins, after the delay has expired, if still failed to open for the second time, the module will send out fail to open alarm.
7	Again Open Delay	(0-20.0)s	0.0	When the breaker fail to close for the first time, then the module will open for the second time and the "Again Open Delay" begins, after the delay has expired, if still failed to close for the second time, the module will send out fail to close alarm.
8	Forced Open Action	(0-1)	0	0: Warn Alarm 1: Fault Alarm
9	Continually Close	(0-1)	0	0: Disable ; 1: Enable If switch close control is continuous signals and "Enable" is selected, "Close Time" and "Open Time" are deactivated.
10	Switch Power Type	(0~1)	1	0: DC Supply; 1: AC Supply
11	AC Volt Lower Limit	(0~100)%	70	Lower limit voltage of switch power; The switch cannot transfer when the value has fallen below the set value.
12	AC Volt Upper Limit	(0~200)%	200	Upper limit voltage of switch power; The switch cannot transfer when the value has exceeded the set value.
13	Switch Type	(0~2)	1	0: PC Three-stage with two breakings; 1: PC Three-stage with one breakings; 2: PC Two-stage;
14	Elevator Control	(0~1)	0	0: Disable ; 1: Enable
15	Elevator Delay	(0-300)s	300	Delay time before load disconnection or switch transfer. Used for control the running elevator stops at the nearest floor until the switch transfer is terminated.
16	AC Supply Abnormal Manual Transfer	(0-1)	1	0: Disable ; 1: Enable
Generator				
1	Start Delay	(0-9999)s	1	When the genset is ready to start, start



No.	Item	Range	Default	Description	
				delay begins, after the start delay has expired, start signal will be initiated.	
2	Stop Delay	(0-9999)s	5	When the genset is ready to stop, stop delay begins, after the stop delay has expired, stop signal will be initiated.	
3	Gen-Gen Start Mode	(0~3)	0	0: Cycs Run 1: Master Run 2: Balance Run 3: Not Used	
4	S1 Cycle Running Time	(0-9999)min	720	Gens cycle start S1 running time.	
5	S2 Cycle RunningTime	(0-9999)min	720	Gens cycle start S2 running time.	
6	S3 Cycle RunningTime	(0-9999)min	720	Gens cycle start S3 running time.	
7	Supply Delay	(0-9999)s	120	Time duration from genset start signal initiated to genset voltage is normal. If the gen voltage lasts abnormal after the delay has expired, "Genset Fault" alarm will be initiated.	
8	Battery Volt Detect	(0-1)	0	0: Disable ; 1: Enable	
9	Battery Under Volt Warn	Set Value	(0-100.0)V	10.0	"Battery Under Volts" alarm will be initiated if the battery voltage has fallen below the set value, and delay fixed as 60s.
10		Return Value	(0-100.0)V	10.5	"Battery Under Volts" alarm will be removed if the battery voltage has exceeded the set value.
11	Battery Over Volt Warn	Set Value	(0-100.0)V	30.0	"Battery Over Volts" alarm will be initiated if the battery voltage has exceeded the set value, and delay fixed as 60s.
12		Return Value	(0-100.0)V	29.5	"Battery Over Volts" alarm will be removed if the battery voltage has fallen below the set value.
Scheduler					
1	Schedule Run	(0-1)	0	0: Disable ; 1: Enable	
2	Run Mode	(0-1)	0	0: Off Load 1: On Load	
3	Cycle Selection	(0-2)	0	0: Monthly 1: Weekly 2: Daily	
4	Time (Month)	(1~4095)	4095	Bit0: Jan. Bit1: Feb. Bit2: Mar. Bit3: Apr.	



No.	Item	Range	Default	Description
				Bit4: May Bit5: June Bit6: July Bit7: Aug. Bit8: Sep. Bit9: Oct. Bit10: Nov. Bit11: Dec.
5	Time (Day)	(1~31)	1	The date of start the genset
6	Time (Week)	(1-127)	1	Bit0: Sunday Bit1: Monday Bit2: Tuesday Bit3: Wednesday Bit4: Thursday Bit5: Friday Bit6: Saturday
7	Time (Hour)	(0-23)h	0	The time of start the genset
8	Time (Minute)	(0-59)min	0	
9	Duration	(0-30000)min	30	The duration time of genset running
10	Scheduled Not Run	(0~1)	0	0: Disable 1: Enable
11	Run Mode	(0-2)	0	0: Monthly 1: Weekly 2: Daily
12	Time (Month)	(1~4095)	4095	Bit0: Jan. Bit1: Feb. Bit2: Mar. Bit3: Apr. Bit4: May Bit5: June Bit6: July Bit7: Aug. Bit8: Sep. Bit9: Oct. Bit10: Nov. Bit11: Dec.
13	Time (Day)	(1~31)	1	The date of <i>NOT</i> start the genset
14	Time (Week)	(1-127)	1	Bit0: Sunday Bit1: Monday Bit2: Tuesday



No.	Item	Range	Default	Description	
				Bit3: Wednesday Bit4: Thursday Bit5: Friday Bit6: Saturday	
15	Time (Hour)	(0-23)	0	The time of <i>NOT</i> start the genset	
16	Time (Minute)	(0-59)	0		
17	Duration	(0-30000)	30	The duration time of genset <i>NOT</i> running	
Load					
1	Current CT Enable	(0-1)	1	0: Disable ; 1: Enable	
2	CT Primary/5	(5-6000)A	500	The primary current of CT.	
3	S1 Full Load Rating	(5-6000)A	500	The current of S1 taking full load	
4	S2 Full Load Rating	(5-6000)A	500	The current of S2 taking full load	
5	S3 Full Load Rating	(5-6000)A	500	The current of S3 taking full load	
6	S1 Max kW Rating	(1-20000)kW	200	The maximum active power of S1 taking load	
7	S2 Max kW Rating	(1-20000)kW	200	The maximum active power of S2 taking load	
8	S3 Max kW Rating	(1-20000)kW	200	The maximum active power of S3 taking load	
9	Over	Enable	(0-1)	1	0: Disable ; 1: Enable
10	Current	Set Value	(0-200)%	120	Over current set value
11	Enable	Action	(0-1)	0	0: Warn 1: Trip
12	Over Current Set	Type	(0-1)	0	0: Definite Time 1: IDMT(Inverse Definite MMinimum Time)
13		Delay	(0-3600)s	10	It's the over current delay time when "Definite Time" is selected.
14		Multiply	(1-36)	36	It's the over current multiply when "IDMT" is selected.
15	NEL Trip	(0-1)	0	0: Disable ; 1: Enable	
16	NEL1 Set Value	(0-200)%	90	Off load output will active if the load power has exceeded the set value and the delay time has expired.	
17	NEL1 Delay	(0-3600)s	5		
18	NEL2 Set Value	(0-200)%	100	Off load output will active if the load power has exceeded the set value and the delay time has expired.	
19	NEL2 Delay	(0-3600)s	1		
20	NEL Return Enable	(0-1)	0	0: Disable ; 1: Enable	
21	Set Value	(0-200)%	50	NEL control will deactivated if the load power has fallen below the set value and the delay time has expired.	
22	Delay	(0-3600)s	5		
23	NEL Num	(1-3)	3	NEL number	
24	Mains Load NEL Enable	(0-1)	0	0: Disable ; 1: Enable	



No.	Item	Range	Default	Description
Digit Inputs				
1	Digital Input 1	(0~47)	1	1: Forced Open
2	Active Type	(0~1)	0	0: Close to activate; 1: Open to activate
3	Digital Input 2	(0~47)	8	8: Breaker Trip Input
4	Active Type	(0~1)	0	0: Close to activate; 1: Open to activate
5	Digital Input 3	(0~47)	0	0: Not Used
6	Active Type	(0~1)	0	0: Close to activate; 1: Open to activate
7	Digital Input 4	(0~47)	0	0: Not Used
8	Active Type	(0~1)	0	0: Close to activate; 1: Open to activate
9	Digital Input 5	(0~47)	0	0: Not Used
10	Active Type	(0~1)	0	0: Close to activate; 1: Open to activate
11	Digital Input 6	(0~47)	0	0: Not Used
12	Active Type	(0~1)	0	0: Close to activate; 1: Open to activate
13	Digital Input 7	(0~47)	0	0: Not Used
14	Active Type	(0~1)	0	0: Close to activate; 1: Open to activate
15	Digital Input 8	(0~47)	0	0: Not Used
16	Active Type	(0~1)	0	0: Close to activate; 1: Open to activate
Relay Outputs				
1	Relay Output 1	(0~1)	0	0: Output (NO) 1: Output (NC)
2	Contents Setting	(0~113)	34	34: QS1 Close Control
3	Relay Output 2	(0~1)	0	0: Output (NO) 1: Output (NC)
4	Contents Setting	(0~113)	35	35: QS1 Open Control
5	Relay Output 3	(0~1)	0	0: Output (NO) 1: Output (NC)
6	Contents Setting	(0~113)	36	36: QS2 Close Control
7	Relay Output 4	(0~1)	0	0: Output (NO) 1: Output (NC)
8	Contents Setting	(0~113)	37	37: QS2 Open Control
9	Relay Output 5	(0~1)	0	0: Output (NO) 1: Output (NC)
10	Contents Setting	(0~113)	38	38: QS3 Close Control



No.	Item	Range	Default	Description
11	Relay Output 6	(0~1)	0	0: Output (NO) 1: Output (NC)
12	Contents Setting	(0~113)	39	39: QS3 Open Control
13	Relay Output 7	(0~1)	0	0: Output (NO) 1: Output (NC)
14	Contents Setting	(0~113)	91	91: QS12 Open Control
15	Relay Output 8	(0~1)	0	0: Output (NO) 1: Output (NC)
16	Contents Setting	(0~113)	92	92: QS12 Close Control
17	Relay Output 9	(0~1)	0	0: Output (NO) 1: Output (NC)
18	Contents Setting	(0~113)	0	0: Not Used
19	Relay Output 10	(0~1)	0	0: Output (NO) 1: Output (NC)
20	Contents Setting	(0~113)	0	0: Not Uesd
21	Relay Output 11	(0~1)	1	0: Output (NO) 1: Output (NC)
22	Contents Setting	(0~113)	32	32: Genset Start Output
23	Relay Output 12	(0~1)	0	0: Output (NO) 1: Output (NC)
24	Contents Setting	(0~113)	0	0: Not Uesd
25	Combined 1 Or Out 1 Active Type	(0~1)	0	0: Output (NO) 1: Output (NC)
26	Combined 1 Or Out 1 Contents Setting	(0~113)	23	23: S1 Available
27	Combined 1 Or Out 2 Active Type	(0~1)	0	0: Output (NO) 1: Output (NC)
28	Combined 1 Or Out 2 Contents Setting	(0~113)	25	25: S2 Available
29	Combined 1 And Out Active Type	(0~1)	1	0: Output (NO) 1: Output (NC)
30	Combined 1 And Out Contents Setting	(0~113)	0	0: Not Uesd
31	Combined 2 Or Out 1 Active Type	(0~1)	0	0: Output (NO) 1: Output (NC)
32	Combined 2 Or Out 1 Contents Setting	(0~113)	0	0: Not Uesd
33	Combined 2 Or Out 2 Active Type	(0~1)	0	0: Output (NO) 1: Output (NC)
34	Combined 2 Or Out 2 Contents Setting	(0~113)	0	0: Not Uesd
35	Combined 2 And Out Active Type	(0~1)	0	0: Output (NO) 1: Output (NC)



No.	Item	Range	Default	Description
36	Combined 2 And Out Contents Setting	(0~113)	0	0: Not Uesd
37	Combined 3 Or Out 1 Active Type	(0~1)	0	0: Output (NO) 1: Output (NC)
38	Combined 3 Or Out 1 Contents Setting	(0~113)	0	0: Not Uesd
39	Combined 3 Or Out 2 Active Type	(0~1)	0	0: Output (NO) 1: Output (NC)
40	Combined 3 Or Out 2 Contents Setting	(0~113)	0	0: Not Uesd
41	Combined 3 And Out Active Type	(0~1)	0	0: Output (NO) 1: Output (NC)
42	Combined 3 And Out Contents Setting	(0~113)	0	0: Not Uesd
43	Combined 4 Or Out 1 Active Type	(0~1)	0	0: Output (NO) 1: Output (NC)
44	Combined 4 Or Out 1 Contents Setting	(0~113)	0	0: Not Uesd
45	Combined 4 Or Out 2 Active Type	(0~1)	0	0: Output (NO) 1: Output (NC)
46	Combined 4 Or Out 2 Contents Setting	(0~113)	0	0: Not Uesd
47	Combined 4 And Out Active Type	(0~1)	0	0: Output (NO) 1: Output (NC)
48	Combined 4 And Out Contents Setting	(0~113)	0	0: Not Uesd
49	Combined 5 Or Out 1 Active Type	(0~1)	0	0: Output (NO) 1: Output (NC)
50	Combined 5 Or Out 1 Contents Setting	(0~113)	0	0: Not Uesd
51	Combined 5 Or Out 2 Active Type	(0~1)	0	0: Output (NO) 1: Output (NC)
52	Combined 5 Or Out 2 Contents Setting	(0~113)	0	0: Not Uesd
53	Combined 5 And Out Active Type	(0~1)	0	0: Output (NO) 1: Output (NC)
54	Combined 5 And Out Contents Setting	(0~113)	0	0: Not Uesd
55	Combined 6 Or Out 1 Active Type	(0~1)	0	0: Output (NO) 1: Output (NC)
56	Combined 6 Or Out 1 Contents Setting	(0~113)	0	0: Not Uesd
57	Combined 6 Or Out 2 Active Type	(0~1)	0	0: Output (NO) 1: Output (NC)
58	Combined 6 Or Out 2 Contents Setting	(0~113)	0	0: Not Uesd



No.	Item	Range	Default	Description
	Contents Setting			
59	Combined 6 And Out Active Type	(0~1)	0	0: Output (NO) 1: Output (NC)
60	Combined 6 And Out Contents Setting	(0~113)	0	0: Not Used
Module Settings				
1	Power On Mode	(0-2)	0	0: Last Mode (Keep the working mode last time running) 1: Manual Mode 2: Auto Mode
2	Language	(0~2)	0	0: Simplified Chinese 1: English 2: Other (Language can be set via PC software, Default: Traditional Chinese)
3	Password	(00000~65535)	01234	For entering parameters setting.
4	Module Address	(1~254)	1	RS485 communication address
5	RS485-1 Baud Rate	(0~3)	2	0: 2400bps 1: 4800bps 2: 9600bps 3: 19200bps
6	RS485-1 Stop Bit	(1~2)	2	2 stop bits or 1 stop bit can be set.
7	RS485-2 Baud Rate	(0~3)	2	0: 2400bps 1: 4800bps 2: 9600bps 3: 19200bps
8	RS485-2 Stop Bit	(1~2)	2	2 stop bits or 1 stop bit can be set.
9	Date and Time			
10	Controller Description 1	(0~20) characters		"About" information is displayed. Any characters can be inputted via PC software (letter occupies 1 character, Chinese character occupies 2.).
11	Controller Description 2	(0~20) characters		

8.3 DIGITAL INPUT/OUTPUT FUNCTION DESCRIPTION

8.3.1 INPUT PORTS FUNCTION

Table 17 – Input Ports Function Description

No.	Item	Description
0	Not Uesd	Invalid
1	Forced Open	No matter the genset is in manual mode or Auto mode, when the input is active, this will force the breaker to transfer the ATS to OFF position. "No Breaking" ATS is unavailable.
2	Remote StartOnLoad	When active, controller will send genset start signal immediately. When mains is normal, genset will close the breaker.
3	Remote StartOffLoad	When active, controller will send a genset start signal immediately. When mains is normal, genset will not close the breaker.
4	Lamp Test	When active, all LED lights on the front panel are illuminated and the backlight of the LCD is illuminated while the LCD screen is black in color.
5	Gen1 Fault Input	In Cycle start, if the input is active, S1 Gens start will be inhibited.
6	Gen2 Fault Input	In Cycle start, if the input is active, S2 Gens start will be inhibited.
7	Start Inhibit Input	In Auto mode, start signal will deactivated after the stop delay has expired. In Manual mode, if the genset is running, users should stop it manually; then the manual start signal will deactivated.
8	Breaker Trip Input	Trip failure input
9	S1 Close Inhibit	In Manual mode, S1 manual close is inhibited; if breaker already closed, users should open it manually. In Auto mode, if breaker already closed, then close relay will deactivated or S2 take load.
10	S2 Close Inhibit	In Manual mode, S2 manual close is inhibited; if breaker already closed, users should open it manually. In Auto mode, if breaker already closed, then close relay will deactivated or S1 take load.
11	QS1 Breaker PF Input	When the S1 PF input is active, S1 close relay will activated.
12	QS2 Breaker PF Input	When the S2 PF input is active, S2 close relay will activated.
13	Reserved	
14	Reserved	
15	Alarm Reset	Reset the current alarm.
16	Alarm Mute	Silence the audible alarm.
17	NEL Trip Key	Control the NEL off load manually. Self-reset button is recommended.
18	NEL Return Key	Control the NEL on load again manually. Self-reset button is recommended.



No.	Item	Description
19	S1 Master Input	Set S1 master use compulsively.
20	S2 Master Input	Set S2 master use compulsively.
21	Forced Manual Mode	Set the controller in Manual mode compulsively.
22	Forced Auto Mode	Set the controller in Auto mode compulsively.
23	Panel Lock	Panel button operation are inhibited (Except Up, Down, Test and Confirm keys)
24	Reserved	
25	Scheduler Inhibit	Schedule Start and Schedule Not Start function are deactivated.
26	Simulate S1 OK	Simulate S1 voltage is normal; the S1 voltage abnormal delay is deactivated.
27	Simulate S2 OK	Simulate S2 voltage is normal; the S2 voltage abnormal delay is deactivated.
28	Simulate S3 OK	Simulate S3 voltage is normal; the S3 voltage abnormal delay is deactivated.
29	QS3 Breaker PF Input	When the S3 PF input is active, S3 close relay will activated.
30	S3 Close Inhibit	S3 load is inhibit
31	Gen3 Fault Input	In Cycle start, if the input is active, S3 Gens start will be inhibited.
32	Reserved	
33	Auto Charge/Rec.	Auto charge/recover when the input active, auto transfer/nonrestore when invalid.
34	S3 Master Input	S3 has the highest priority.
35	Reserved	
36	Reserved	
37	Simulate KEY OOO	Same function with Panel OOO Key. Please use reset key to control ATS to transfer to OOO.
38	Simulate KEY OOI	Same function with Panel OOI Key. Please use reset key to control ATS to transfer to OOI.
39	Simulate KEY IOO	Same function with Panel IOO Key. Please use reset key to control ATS to transfer to IOO.
40	Reserved	
41	Reserved	
42	Reserved	
43	Simulate KEY OIO	Same function with Panel OIO Key. Please use reset key to control ATS to transfer to OIO.
44	QS12 Breaker PF Input	QS12 close ready signal input. Before close QS12, it should wait QS12PF input active.



No.	Item	Description
45	Remote Control Inhibit	Remote control is invalid when the input is active.
46	Reserved	
47	Reserved	

8.4 OUTPUT PORTS FUNCTION

Table 18 – Output Ports Function Description

No.	Items	Description
0	Not Used	Invalid
1	Custom Combined 1	
2	Custom Combined 2	
3	Custom Combined 3	
4	Custom Combined 4	
5	Custom Combined 5	
6	Custom Combined 6	
7	Reserved	
8	Reserved	
9	Reserved	
10	Reserved	
11	Common Alarm	It includes fault alarm and warning alarms.
12	Common Fault Alarm	It includes “Transition Fault” alarm and “Over Current Trip” alarm.
13	Common Warn Alarm	It includes “S1 Phase Sequence Wrong” alarm, “S2 Phase Sequence Wrong” alarm, “Load Over Current” and “Forced Open” alarm.
14	Transition Fault	It includes “QS1 Fail to Close” alarm, “QS1 Fail to Open” alarm, “QS2 Fail to Close” alarm, “QS2 Fail to Open” alarm, “QS3 Fail to Close” alarm, “QS3 Fail to Open” alarm, “QS12 Fail to Close” alarm and “QS12 Fail to Open” alarm.
15	Audible Alarm	Action when common alarm occurs. Can be connected annunciator externally. When “alarm mute” input is active or 60s delay has expired, it can remove the alarm.
16	Reserved	
17	Genset Start Delay	Output when start signal is initiated.
18	Genset Stop Delay	Output when stop signal is initiated.
19	Elevator Control	Output before the load disconnection or switch transfer. Used for control the running elevator stop at the nearest floor until the switch transfer is terminated.
20	Reserved	
21	S3 Available	
22	S3 Unavailable	
23	S1 Available	Output when S1 power is normal.



No.	Items	Description
24	S1 Unavailable	Output when S1 power is abnormal.
25	S2 Available	Output when S2 power is normal.
26	S2 Unavailable	Output when S2 power is abnormal.
27	S1 Over Current	Output when S1 over current occurs.
28	S2 Over Current	Output when S2 over current occurs.
29	S3 Over Current	Output when S3 over current occurs.
30	Auto Mode	Output when the genset is in Auto mode.
31	Manual Mode	Output when the genset is in Manual mode.
32	Genset Start Output	Control the genset to start.
33	Reserved	
34	QS1 Close Control	Control the QS1 switch to close.
35	QS1 Open Control	Control the QS1 switch to open.
36	QS2 Close Control	Control the QS2 switch to close.
37	QS2 Open Control	Control the QS2 switch to open.
38	QS3 Close Control	Control the QS3 switch to close.
39	QS3 Open Control	Control the QS3 switch to open.
40	NEL1 Trip	Control the NEL off load when the output is active; It can control the NEL on load again when the output deactivated.
41	NEL2 Trip	
42	NEL3 Trip	
43	Reserved	
44	QS3 Closed Input	The close status of S3 switch
45	QS1 Closed Input	The close status of S1 switch
46	QS2 Closed Input	The close status of S2 switch
47	S1 Genset Start	When the system type is "S1 Gen S2 Gen", it controls the S1 genset start.
48	S2 Genset Start	When the system type is "S1 Gen S2 Gen", it controls the S2 genset start.
49	S1S2S3 ATS PowerL1	ATS power supply
50	Reserved	
51	Reserved	
52	S1S2S3 ATS PowerN	
53	Remote Control	Control the output via RS485 command.
54	Input 1 Status	Programmable Input status.
55	Input 2 Status	
56	Input 3 Status	
57	Input 4 Status	
58	Input 5 Status	
59	Input 6 Status	
60	Input 7 Status	
61	Input 8 Status	
62	Reserved	
63	Reserved	



No.	Items	Description
64	S1 Blackout	S1 power supply status
65	S1 Over Volt	
66	S1 Under Volt	
67	S1 Over Freq	
68	S1 Under Freq	
69	S1 Loss Of Phase	
70	S1 Phase Seq Wrong	
71	Reserved	
72	Reserved	
73	S2 Blackout	S2 power supply status
74	S2 Over Volt	
75	S2 Under Volt	
76	S2 Over Freq	
77	S2 Under Freq	
78	S2 Loss Of Phase	
79	S2 Phase Seq Wrong	
80	Reserved	
81	Reserved	
82	Reserved	
83	Reserved	
84	Switching	Output during the switch transfer process.
85	Battery Under Volt	Output when battery under voltage alarm occurs.
86	Battery Over Volt	Output when battery over voltage alarm occurs.
87	Gen Inhibit Work	Output during the Schedule Not Run process.
88	Scheduler Gen Start	Output during the Schedule Run process.
89	Reserved	
90	SQ12 Closed Input	
91	SQ12 Close Control	
92	SQ12 OOpen Control	
93	Reserved	
94	Reserved	
95	Reserved	
96	Reserved	
97	Reserved	
98	S3 Blackout	S3 power supply status
99	S3 Over Volt	
100	S3 Under Volt	
101	S3 Over Freq	
102	S3 Under Freq	
103	S3 Loss of Phase	
104	S3 Phase Seq Wrong	
105	Reserved	



No.	Items	Description
106	Reserved	
107	S3 Genset Start	Control S3 Genset to start. Used for Gen-Gen system and S3 Gens.
108	Reserved	
109	Reserved	
110	Reserved	
111	Reserved	
112	Reserved	
113	Reserved	

SmartGen

8.4.1 CUSTOM COMBINED

Defined combination output is composed by 3 parts, OR condition output SW1, OR condition output SW2, AND condition output SW3.

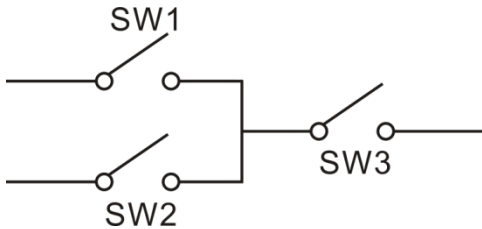

SW1 or SW2 is **TRUE**, while SW3 is **TRUE**, Defined combination output is active;

SW1 and SW2 are **FALSE**, or SW3 is **FALSE**, Defined combination output is deactivated.

NOTE: SW1, SW2, SW3 can be set as any contents except for “defined combination output” in the output setting.

NOTE: 3 parts of defined combination output (SW1, SW2, SW3) couldn't include or recursively include themselves.

Example,

Contents of OR condition output SW1: output port 1 is active;

Close when OR condition output SW1 is active /inactive: close when active (disconnect when inactive);

Contents of OR condition output SW2, output port 2 is active;

Close when OR condition output SW2 is active /inactive: close when active (disconnect when inactive);

Contents of AND condition output SW3: output port 3 is active;

Close when AND condition output SW3 is active /inactive: close when active (disconnect when inactive);

When input port 1 active or input port 2 active, if input port 3 is active, Defined combination output is outputting; If input port 3 inactive, Defined combination output is not outputting;

When input port 1 inactive and input port 2 inactive, whatever input port 3 is active or not, Defined combination output is not outputting.

8.5 DEFINITE TIME DELAY AND INVERSE DEFINITE MINIMUM TIME SETTING

Definite Time: overcurrent delay is definite time delay. Different overcurrent value has corresponding delay.

Inverse Definite Minimum Time(IDMT): overcurrent delay decrease with the increase of overcurrent. Different overcurrent value has corresponding delay.

IDMT formula:

$$T = t / ((IA/IT)-1)^2$$

T: Overcurrent delay (second)

t: Timing multiplier ratio

IA: Current max. load current (L1/L2/L3)

IT: Overcurrent setting value

Example:

$$t = 36$$



$$IA = 550A$$

$$IT = 500A$$

Conclusion: T = 3600s(1hour)

SmartGen

9 HISTORICAL RECORDS

On the main screen press  key and select **Historical Records**, and then press  key again, the screen will show the historical records interface.

Each record includes:

- Record date and time
- Record type
- Event log
- S1 power supply status
- S2 power supply status
- S3 power supply status
- S1 3-phase voltage
- S2 3-phase voltage
- S3 3-phase voltage
- S1 frequency
- S2 frequency
- S3 frequency
- Load current
- Total active power
- Everage power factor

Maximum pieces of historical record are 200. The first record is latest, and users could check every records by dredge up/down. The latest record will cover the oldest one when records amount exceed 200.

Event log type includes: Action Event, Warn Event and Fault Event. All fault event actions are fault alarm while all warn event actions are warn alarm.



Table 19 – Action Events List

No.	Action Events	Description
1	Closing QS1	Record when the QS1 close relay activated.
2	Closing QS2	Record when the QS2 close relay activated.
3	Closing QS3	Record when the QS3 close relay activated.
4	Closing QS12	Record when the QS12 close relay activated.
5	Opening QS1	Record when the QS1 open relay activated.
6	Opening QS2	Record when the QS2 open relay activated.
7	Opening QS3	Record when the QS3 open relay activated.
8	Opening QS12	Record when the QS12 open relay activated.
9	NEL1 Trip	Record when the NEL 1 Trip output.



No.	Action Events	Description
10	NEL2 Trip	Record when the NEL 2 Trip output.
11	NEL3 Trip	Record when the NEL 3 Trip output.
12	Genset Start	Record when the Genset Start signal output.
13	S1 Genset Start	Record when the S1 Genset Start signal output.
14	S2 Genset Start	Record when the S2 Genset Start signal output.
15	S3 Genset Start	Record when the S3 Genset Start signal output.
16	Genset Stop	Record when the Genset Start signal deactivated.
17	S1 Genset Stop	Record when the S1 Genset Start signal deactivated.
18	S2 Genset Stop	Record when the S2 Genset Start signal deactivated.
19	S3 Genset Stop	Record when the S3 Genset Start signal deactivated.
20	Auto Mode	Record when the genset mode transferred to Auto Mode.
21	Manual Mode	Record when the genset mode transferred to Module Mode.

10 BLACK BOX RECORDS

On the main screen press /OK key and select **Black Box Records**, and then press /OK key again, the screen will show the black box records interface.

Each record includes:

- Record date and time
- Record type
- Event log
- S1 power supply status
- S2 power supply status
- S3 power supply status
- S1 3-phase voltage
- S2 3-phase voltage
- S3 3-phase voltage
- S1 frequency
- S2 frequency
- S3 frequency
- Current IA、 IB、 IC
- Active power
- Power factor

Maximum pieces of black box record are 5. Every event records total 60s (before and after) data information of this event, and record once per second. The latest record will cover the oldest one when records amount exceed 5. The first record is latest. Users could check details by pressing Confirm Key, and could check the 60 datas by dredge up/down.

Event log type: the action event of close/open switching in auto mode.

Table 20 – Action Events List

No.	Action Events	Description
1	Auto Action OOO	Open in auto mode
2	Auto Action IOO	QS1 Close in auto mode
3	Auto Action OIO	QS2 Close in auto mode
4	Auto Action OOI	QS3 Close in auto mode





11 SWITCH OPERATION

11.1 MANUAL OPERATION

Manual mode is selected by pressing the  button; a LED besides the button will illuminate to confirm the operation.

ATS will start to switch immediately after pressing Switch Key. During the switching, corresponding lamps will flash, and then the lamp will be normally illuminated when switch is done. If fail to close or fail to open occurs in the switching process, the controller will initiate fault alarm (Switch Key is inactive during alarming, when reset fault alarm, Switch Key is active again).

Table 21 – Manual Transfer Keys

Icon	Key Name	Description
	IOO	After pressing this key, if load is off, QS12, Q1 will close, otherwise the ATS open firstly then QS12, Q1 will close (S1 supply).
	OIO	After pressing this key, if load is off, QS12, QS2 will close, otherwise the ATS open firstly then QS12, QS2 will close (S2 supply).
	OOI	After pressing this key, if load is off, QS3 will close, otherwise the ATS open firstly then QS3 will close (S3 supply).
	OOO	Load is off after pressing this key.

11.2 AUTOMATIC OPERATION

Auto mode is selected by pressing the  button; a LED besides the button will illuminate to confirm the operation.

Under auto mode, the controller will switch automatically to ensure power supply according to S1 S2 S3 status, switch priority and AutoCharge/Recover status. Examples are showed below:

Table 22 – Auto Breaker Transfer Logic

Power Status	Breaker and Load Status	S1>S2>S3	S2>S1>S3	S3>S1>S2
S1 Normal S2 Normal S3 Normal AutoCharge/Recover	Breaker Status	Status IOO QS1 Close QS2 Open QS3 Open	Status OIO QS2 Close QS1 Open QS3 Open	Status OOI QS3 Close QS1 Open QS2 Open
	Load Status	S1 Supply	S2 Supply	S3 Supply
S1 Normal S2 Abnormal S3 Normal AutoCharge/Recover	Breaker Status	Status IOO QS1 Close QS2 Open QS3 Open	Status IOO QS1 Close QS2 Open QS3 Open	Status OOI QS3 Close QS1 Open QS2 Open
	Load Status	S1 Supply	S1 Supply	S3 Supply
S1 Abnormal S2 Normal S3 Normal AutoCharge/Recover	Breaker Status	Status OIO QS2 Close QS1 Open QS3 Open	Status OIO QS2 Close QS1 Open QS3 Open	Status OOI QS3 Close QS1 Open QS2 Open
	Load Status	S2 Supply	S2 Supply	S3 Supply
S1 Abnormal S2 Abnormal S3 Normal	Breaker Status	Status OOI QS3 Close QS1 Open QS2 Open	Status OOI QS3 Close QS1 Open QS2 Open	Status OOI QS3 Close QS1 Open QS2 Open
	Load Status	S3 Supply	S3 Supply	S3 Supply
S1 Abnormal S2 Abnormal S3 Abnormal	Breaker Status	Keep previous status		
	Load Status	Off load		

During the switching process, if fail to close or close inhibit occurs, the corresponding switch will close no more, and other closable switch will supply power. If fail to open occurs, the switch won't execute any order.

12 ATS POWER SUPPLY

Switch Power Type can be set as DC Power or AC Power. If DC Power is selected, then the switch can be transferred at any time (even when both S1 S2 and S3 are power outage). If AC Power is selected, whether the power is normal or not should be judged according to the AN voltage status of S1 S2 and S3 and AC power voltage range.

The controller will intelligent control to supply when the power of ATS switch is from S1 and S2. As long as 1 way voltage of S1 and S2 is normal, the controller can ensure ATS voltage power normal and can be transferred properly. When ATS voltage power is from LO and NO, it will send close/open signal only if the controller detects voltage power normal.

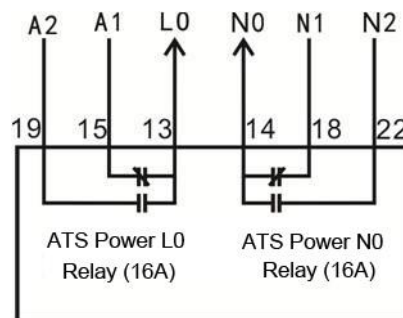

Fig.5 – Internal Wiring of ATS Power LO-NO Output

The controller will intelligent control to supply when the power of ATS switch is from S1 S2 and S3. As long as 1 way voltage of S1 S2 and S3 is normal, the controller can ensure ATS voltage power normal and can be transferred properly. Users need to respectively connect LO, A3 (A phase of S3) to Terminal51 (normally close) and Terminal52 (normally open) of Aux. Output11; and respectively connect NO, N3 (N phase of S3) to Terminal54 (normally close) and Terminal55 (normally open) of Aux. Output12; then connect the COM of Aux. Output11 and 12 to ATS power supply. Then set Aux. Output11 as corresponding phase voltage “S1S2S3ATS PowerL1”, set Aux. Output12 as “S1S2S3ATS Power N” in parameter setting interface. Please refer connection method as below:

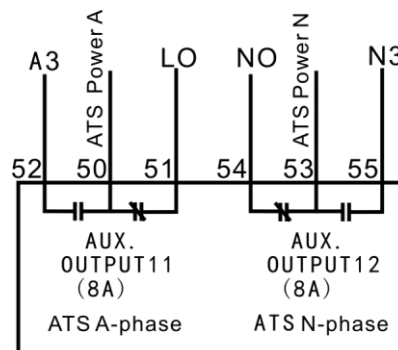

Fig.6 –Wring of ATS Supplied by Any of S1S2S3

13 NEL CONTROL

13.1 ILLUSTRATION

Non-essential load ---- NEL for short, which refers to load can be ramped off in prior when genset power is undercapacity.

The controller can control the NEL1, NEL2 and NEL3 to trip separately. The order of the essentiality is: NEL3 > NEL2 > NEL1

13.2 AUTO OPERATION

When NEL auto trip is enabled:

If the genset power has exceeded the NEL trip value, after the trip delay, NEL1 will trip the earliest, and then is NEL2, NEL3;

When NEL auto reconnection is enabled:

If the genset power has fallen below the auto reconnection set value, after the auto reconnection delay, NEL3 will reconnection the earliest, and then is NEL2, NEL1;

t1: NEL Trip Delay
t2: Reconnection Delay

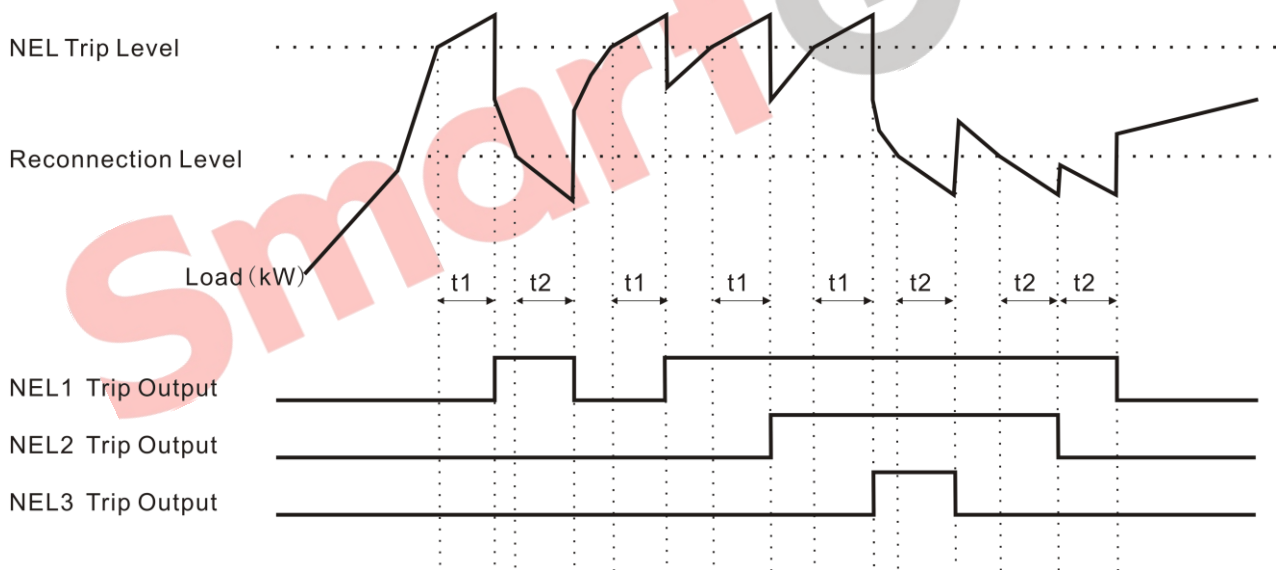

13.3 MANUAL OPERATION

If NEL manual trip input is active (earthed falling edge is active), NEL1 will trip without delay; If NEL manual trip input is active again, NEL2 will trip; If NEL manual trip input is active the third time, NEL3 will trip. During this process, the controller do not detect if the genset power has exceed the NEL trip value or not.

If NEL manual reconnection input is active (earthed falling edge is active), NEL3 will reconnect without delay; If NEL manual reconnection input is active again, NEL2 will reconnect; If NEL manual reconnection input is active the third time, NEL1 will reconnect. During this process, the controller detects the genset power: if the genset power has fallen below the NEL reconnection value, then the

input is active; if it doesn't, the input is deactivated.



Note: When auto trip and auto reconnection are enabled, manual trip is still active.

14 COMMUNICATION CONFIGURATION

HAT832 ATS controller equips with 2 RS485 serial ports which enable the connection of LAN. It uses Modbus protocol via PC or system software, it can also be applicable to dual power switching management to factories, telecom, industrial and civil buildings, which achieves “remote control, remote measuring, remote communication” functions.

More information of Communication Protocol, please refer to “HAT832 Communication Protocol”

Communication parameters:

Module address	1 (range: 1-254)
Baud rate	9600 bps (2400/4800/9600/19200bps)
Data bit	8-bit
Parity bit	None
Stop bit	2 bits (1 bit or 2 bits)

There is a D-type USB port which can be used to connect PC for software upgrading and parameter setting.

SmartGen

15 TERMINALS

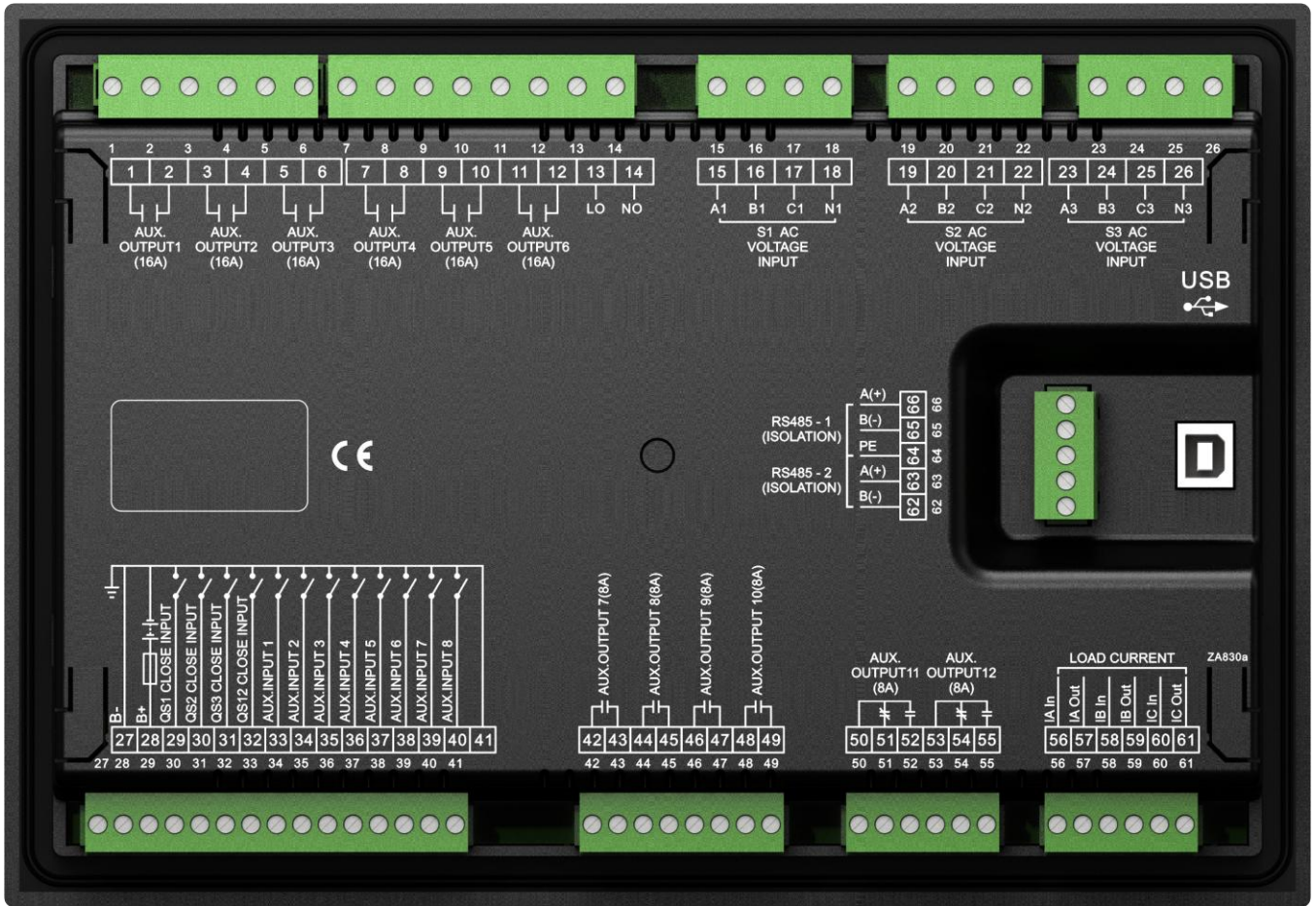

Fig.7 – Controller Rear Panel Drawing

Table 23 – Inputs/Outputs Function Description

No.	Items	Description	Remark
1	AUX.OUTPUT1	Relay Output1	Default: QS1 Close Control
2			Volts free; Relay contact; Normally Open output. Capacity: 250V16A
3	AUX.OUTPUT2	Relay Output2	Default: QS1 Open Control
4			Volts free; Relay contact; Normally Open output. Capacity: 250V16A
5	AUX.OUTPUT3	Relay Output3	Default: QS2 Close Control
6			Volts free; Relay contact; Normally Open output. Capacity: 250V16A
7	AUX.OUTPUT4	Relay Output4	Default: QS2 Open Control
8			Volts free; Relay contact; Normally Open output. Capacity: 250V16A



No.	Items	Description	Remark
9	AUX.OUTPUT5	Relay Output5	Default: QS3 Close Control
10			Volts free; Relay contact; Normally Open output. Capacity: 250V16A
11	AUX.OUTPUT6	Relay Output6	Default: QS3 Open Control
12			Volts free; Relay contact; Normally Open output. Capacity: 250V16A
13	LO	ATS Power L	Power supply for ATS switching (S1 and S2)
14	NO	ATS Power N	
15	A1	S1 AC System 3P4W voltage input	For single phase, only connect A1, N1
16	B1		
17	C1		
18	N1		
19	A2	S2 AC System 3P4W voltage input	For single phase, only connect A2, N2
20	B2		
21	C2		
22	N2		
23	A3	S3 AC System 3P4W voltage input	For single phase, only connect A3, N3
24	B3		
25	C3		
26	N3		
27	B-	Connect to DC negative pole	Ground terminal
28	B+	Connect to DC positive pole	DC(8-35)V; Power supplied by controller.
29	QS1 CLOSE INPUT	QS1 Close Status Input	Detect QS1 close status, volts free, relay contact. Ground connected is active.
30	QS2 CLOSE INPUT	QS2 Close Status Input	Detect QS2 close status, volts free, relay contact. Ground connected is active.
31	QS3 CLOSE INPUT	QS3 Close Status Input	Detect QS3 close status, volts free, relay contact. Ground connected is active.
32	QS12 CLOSE INPUT	QS12 Close Status Input	Detect QS12 close status, volts free, relay contact. Ground connected is active.
33	AUX. INPUT 1	Digital Input1	Default: Forced Open



No.	Items	Description		Remark
				Ground connected is active.
34	AUX. INPUT 2	Digital Input2		Default: Breaker Trip Input Ground connected is active.
35	AUX. INPUT 3	Digital Input3		Default: Not Used Ground connected is active.
36	AUX. INPUT 4	Digital Input4		Default: Not Used Ground connected is active.
37	AUX. INPUT 5	Digital Input5		Default: Not Used Ground connected is active.
38	AUX. INPUT 6	Digital Input6		Default: Not Used Ground connected is active.
39	AUX. INPUT 7	Digital Input7		Default: Not Used Ground connected is active.
40	AUX. INPUT 8	Digital Input8		Default: Not Used Ground connected is active.
41	B-(GND)	Ground terminal		Connect to B- internally.
42	AUX. OUTPUT 7	Relay Output7		Default: QS12 Close Control
43				Volts free; Relay contact; Normally Open output. Capacity: 250V8A
44	AUX. OUTPUT 8	Relay Output8		Default: QS12 Open Control
45				Volts free; Relay contact; Normally Open output. Capacity: 250V8A
46	AUX. OUTPUT 9	Relay Output9		Default: Genset Start
47				Volts free; Relay contact; Normally Open output. Capacity: 250V8A
48	AUX. OUTPUT 10	Relay Output10		Default: Not Used
49				Volts free; Relay contact; Normally Open output. Capacity: 250V8A
50	AUX. OUTPUT 11	COM	Relay Output11	Default: Genset Start Output Volts free; Relay contact; Normally Open/Close output. Capacity: 250V8A
51		Normally Close		
52		Normally Open		
53	AUX. OUTPUT 12	COM	Relay Output12	Default: Not Used Volts free; Relay contact; Normally Open/Close output. Capacity: 250V8A
54		Normally Close		



No.	Items	Description	Remark
55		Normally Open	250V8A
56	IA In	CT Secondary A-Phase current input	
57	IA Out		
58	IB In		
59	IB Out		
60	IC In		
61	IC Out		
62	RS485-2 B(-)	RS485-2 communication port	120Ω impedance matched resistance should be connected according to the different situation.
63	RS485-2 A(+)		
64	PE	Ground terminal	
65	RS485-1 B(-)	RS485-1 communication port	120Ω impedance matched resistance should be connected according to the different situation.
66	RS485-1 A(+)		
USB	USB	D-type USB communication port	Parameters setting and software upgrading via PC

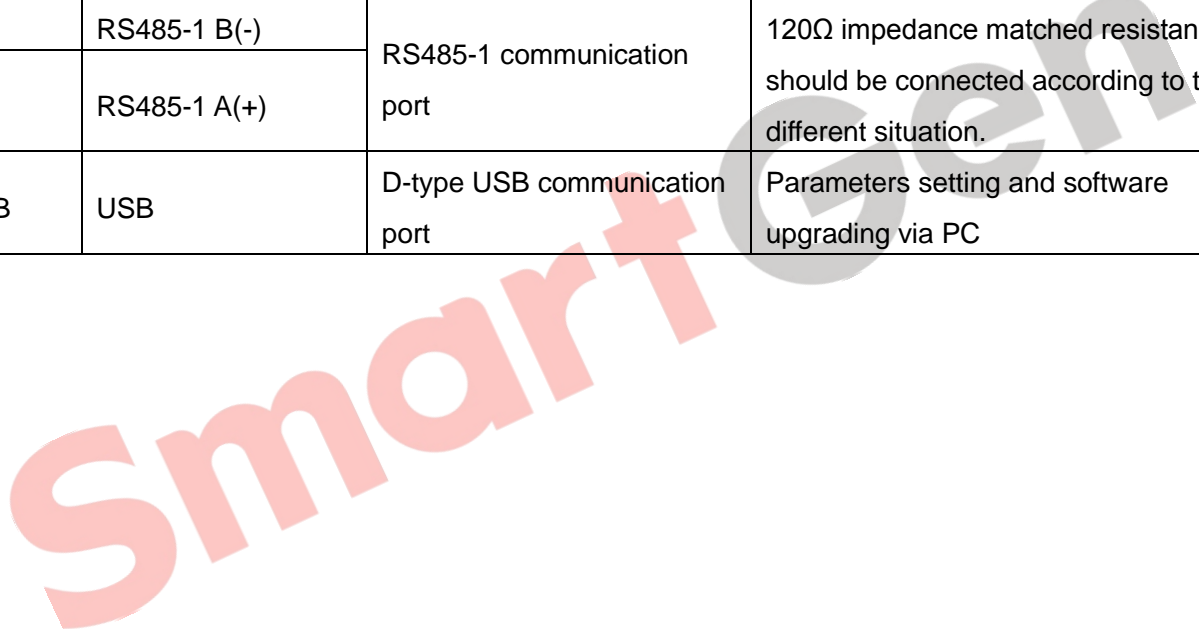

16 TYPICAL WIRING DIAGRAM

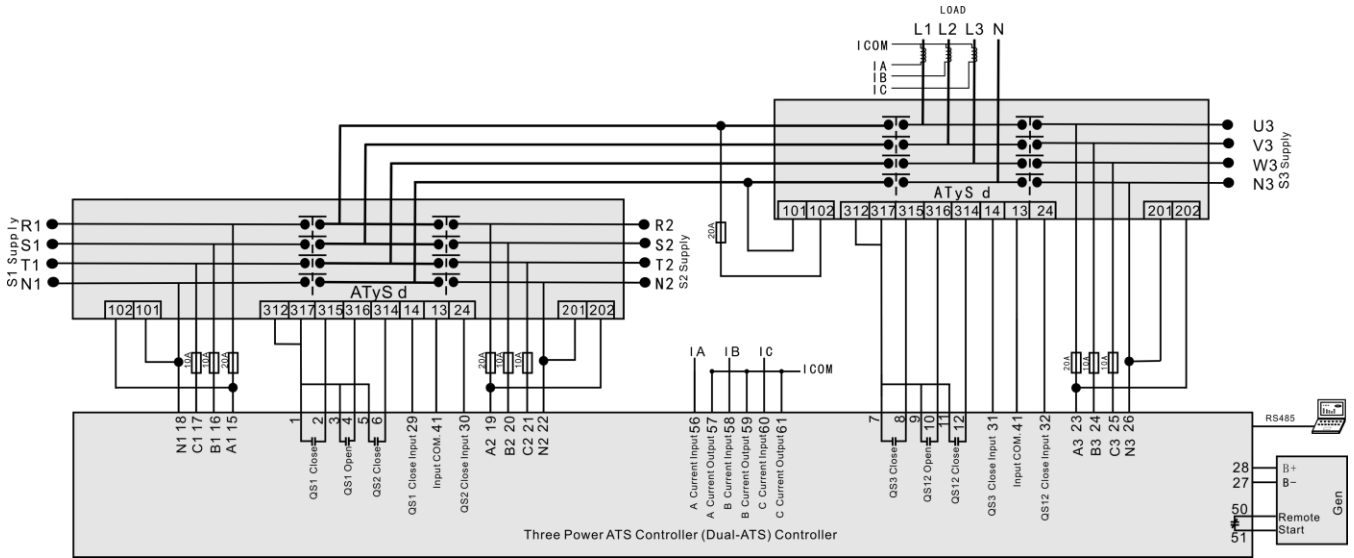

Fig.8 – ATySd Application Diagram 1

Table 24 – Corresponding Settings

Partial Parameters Setting	
System Type	S1M S2M S3G
Switch Type	PC Three-stage with one breaking
Aux. Output 1	QS1 Close
Aux. Output 2	QS1 Open
Aux. Output 3	QS2 Close
Aux. Output 4	QS3 Close
Aux. Output 5	QS12 Open
Aux. Output 6	QS12 Close
Aux. Output 11	GenSet Start Output
Note: ATS power supply is provided by this power.	

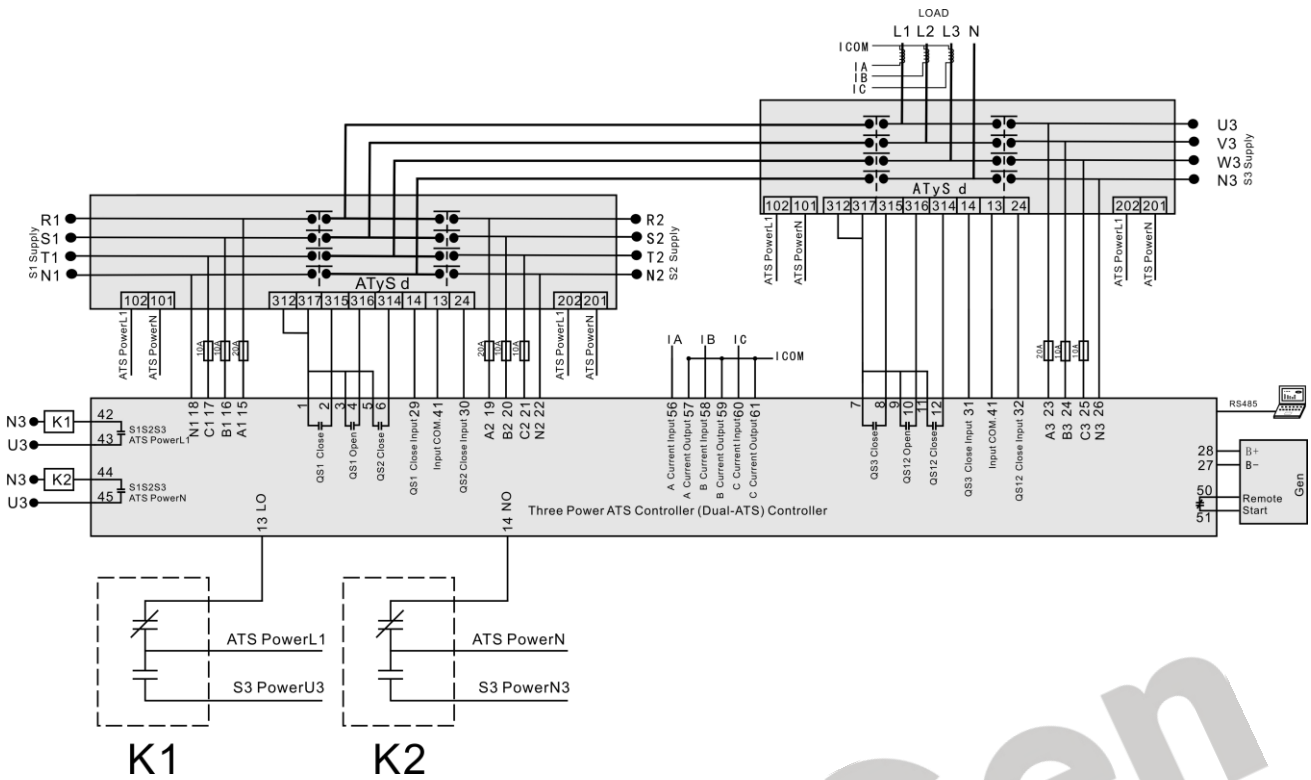

Fig.9 – ATyS d Application Diagram 2

Table 25 – Corresponding Settings

Partial Parameters Setting	
System Type	S1M S2M S3G
Switch Type	PC Three-stage with one breaking
Aux. Output 1	QS1 Close
Aux. Output 2	QS1 Open
Aux. Output 3	QS2 Close
Aux. Output 4	QS3 Close
Aux. Output 5	QS12 Open
Aux. Output 6	QS12 Close
Aux. Output 7	S1S2S3ATS power L1
Aux. Output 8	S1S2S3ATS power N
Aux. Output 11	Genset Start Ouptut
Note: ATS power supply is provided by external expand relay.	

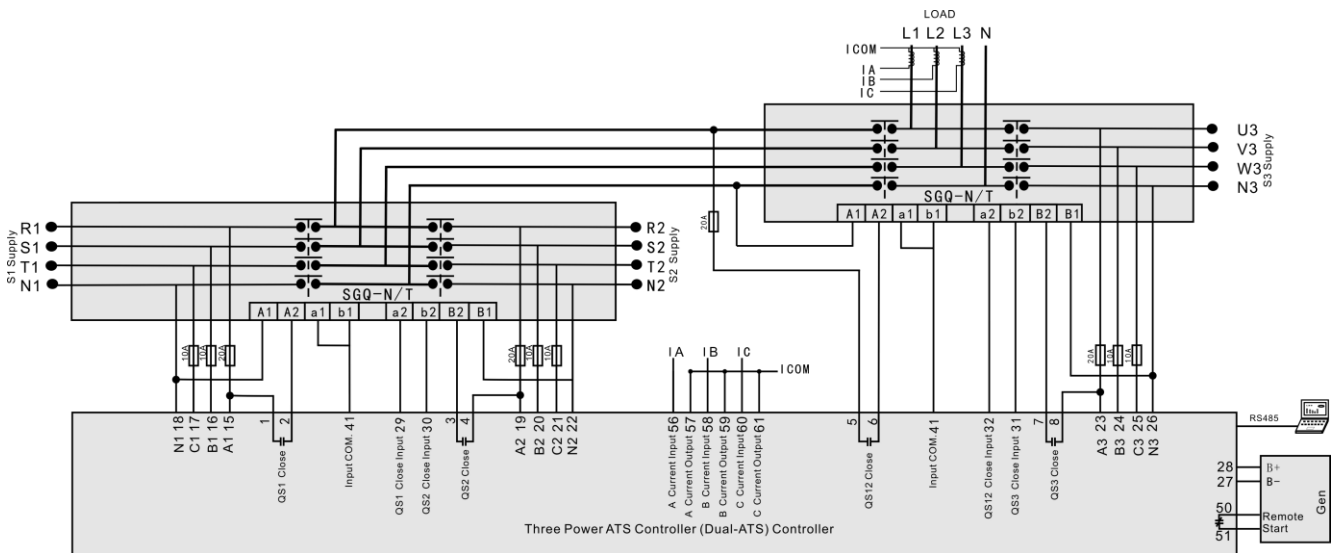

Fig.10 - SGQ-N/T Application Diagram

Table 26 – Corresponding Settings

Partial Parameters Setting	
System Type	S1M S2M S3G
Switch Type	PC Two-stage
Aux. Output 1	QS1 Close
Aux. Output 2	QS2 Close
Aux. Output 3	QS12 Close
Aux. Output 4	QS3 Close
Aux. Output 11	Genset Start Output

Note: The diagrams above are only for example, please do wiring according to actual conditions.

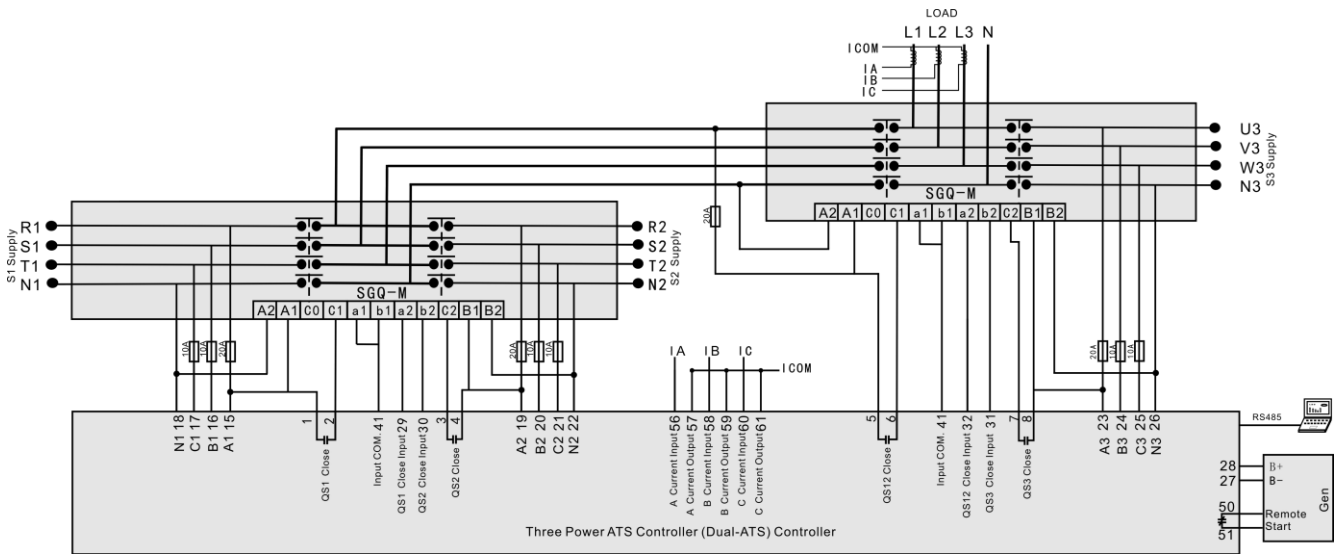

Fig.11 - SGQ-M Application Diagram

Table 27 – Corresponding Settings

Partial Parameters Setting	
System Type	S1M S2M S3G
Switch Type	PC Two-stage
Aux. Output 1	QS1 Close
Aux. Output 2	QS2 Close
Aux. Output 3	QS12 Close
Aux. Output 4	QS3 Close
Aux. Output 11	Genset Start Output

Note: The diagrams above are only for example, please do wiring according to actual conditions.

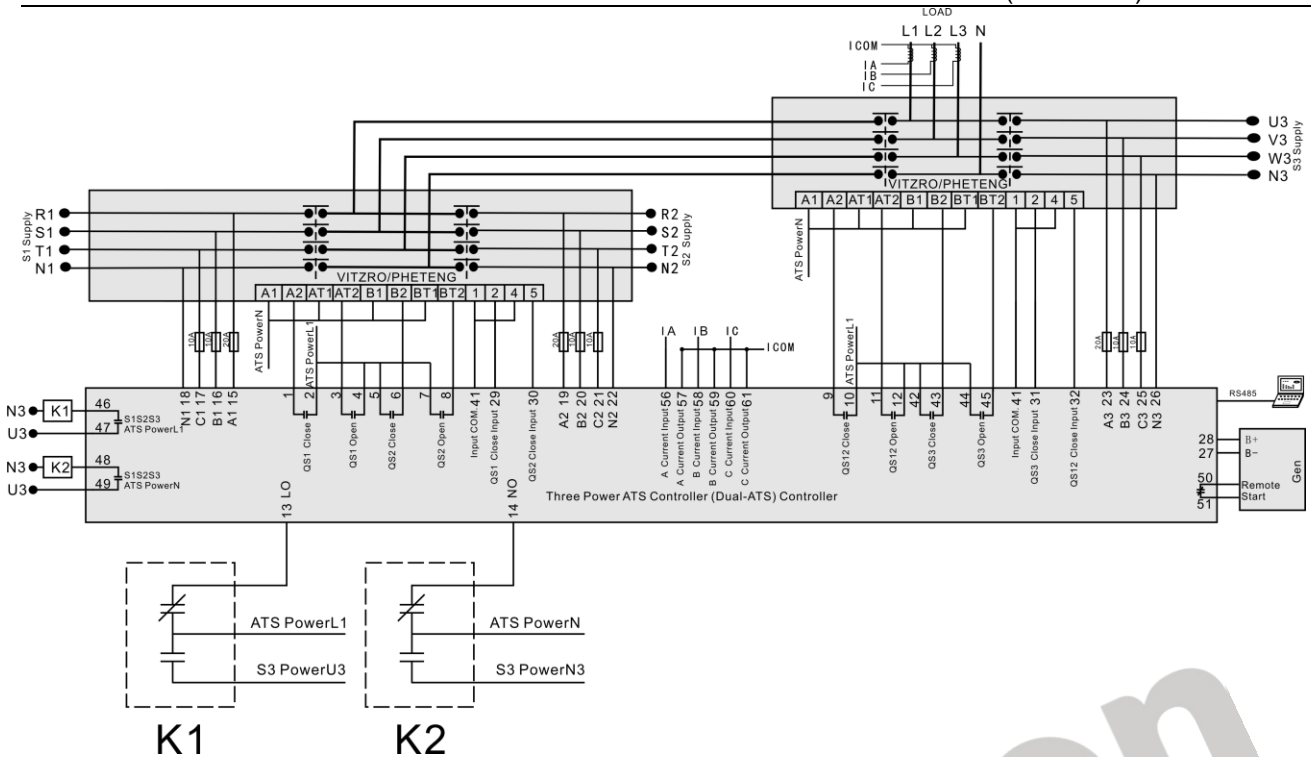

Fig.12 – VITZRO/PHETENG Application Diagram

Table 28 – Corresponding Settings

Partial Parameters Setting	
System Type	S1M S2M S3G
Switch Type	PC Three-stage with two breakings
Aux. Output 1	QS1 Close
Aux. Output 2	QS1 Open
Aux. Output 3	QS2 Close
Aux. Output 4	QS2 Open
Aux. Output 5	QS12 Close
Aux. Output 6	QS12 Open
Aux. Output 7	QS3 Close
Aux. Output 8	QS3 Open
Aux. Output 9	S1S2S3ATS power L1
Aux. Output 10	S1S2S3ATS power N
Aux. Output 11	Genset Start Output

Note: ATS power supply is provided by external expand relay.

Note: The diagrams above are only for example, please do wiring according to actual conditions.

17 INSTALLATION

Controller is panel built-in design; it is fixed by clips when installed.

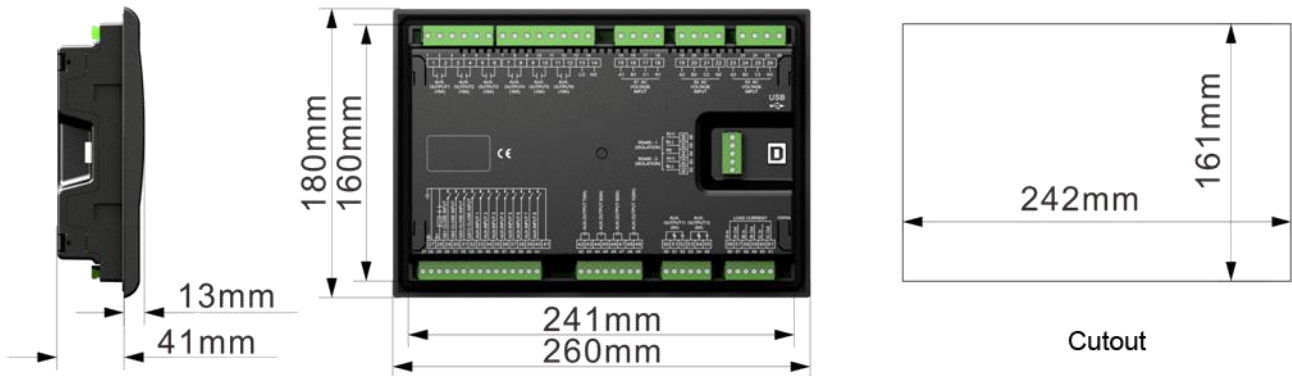

Fig.13 – Overall & Cutout Dimensions

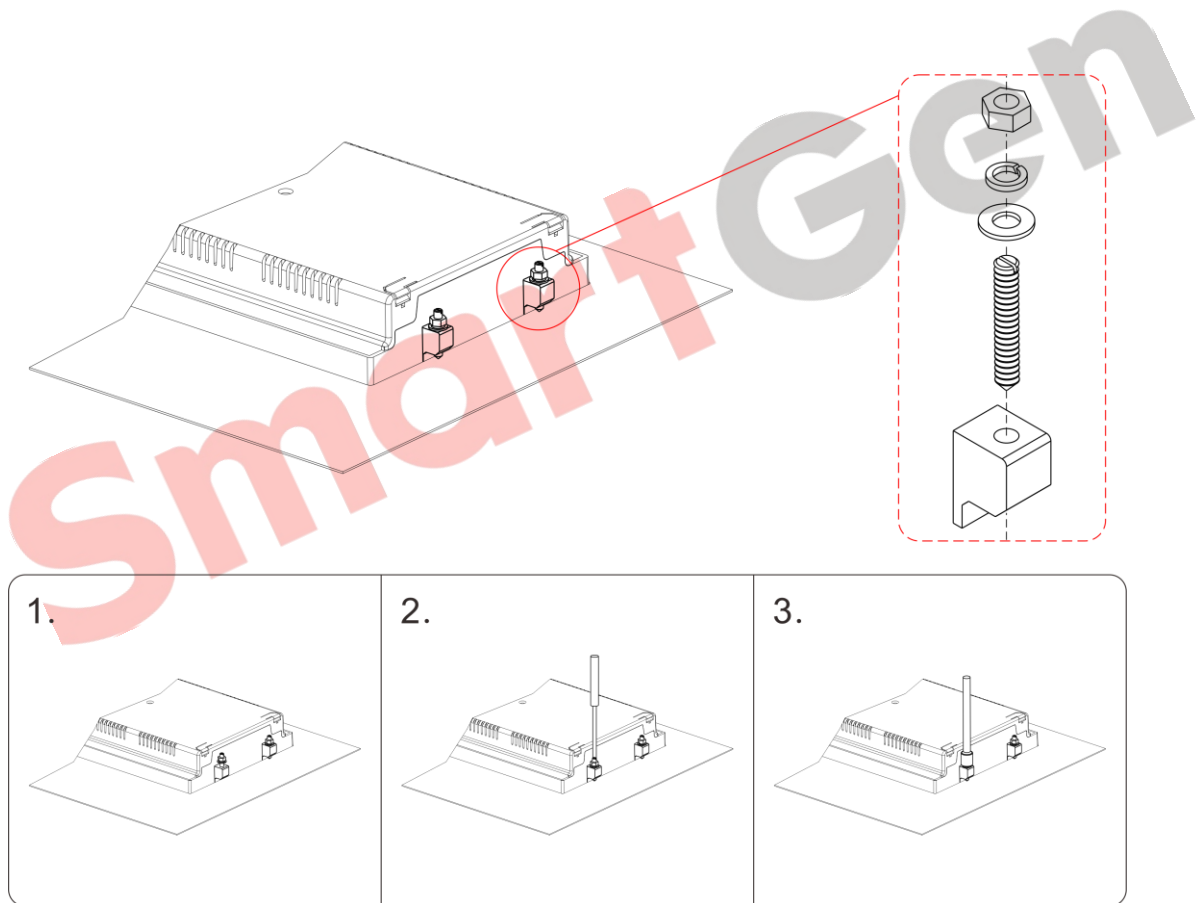

Fig.14 – Clips Installation Drawing

Installation Steps:

1. Install these 4 clips (put into grooves in front panel) in turn.
2. Tighten the screws by using straight screwdriver.
3. Tighten the 4 hex nuts by using M4 sleeve.

18 TROUBLE SHOOTING

Table 29 - Troubleshooting

Symptoms	Possible Solutions
Controller no response with power.	Check DC voltage. Check DC fuse. Check AC Power supply.
RS485 communication is abnormal	Check RS485's connections of positive and negative is reverse connect or not. Check RS485 transfer model whether damage or not. Check the module address. If above methods can't solve the problem, parallel connection 120Ω resistor between RS485 A terminal and B terminal is recommended.
Auxiliary Output Error	Check auxiliary output connections, pay attention to normally open contact and normally close contact. Check the output settings in parameters settings.
Auxiliary Input Abnormal	Ensure that the auxiliary input is soundly connected to GND when it's active, while hung up when it is inactive. (▲Note: The input port will be possibly destroyed when connected with voltage) Check the input settings in parameters settings.
Genset running while ATS not transfer	Check ATS. Check the connection wirings between the controller and the ATS. Check ATS settings.
Genset Start Abnormal	Check system type setting. Check the output settings and output type. Check all Start/Stop settings.