

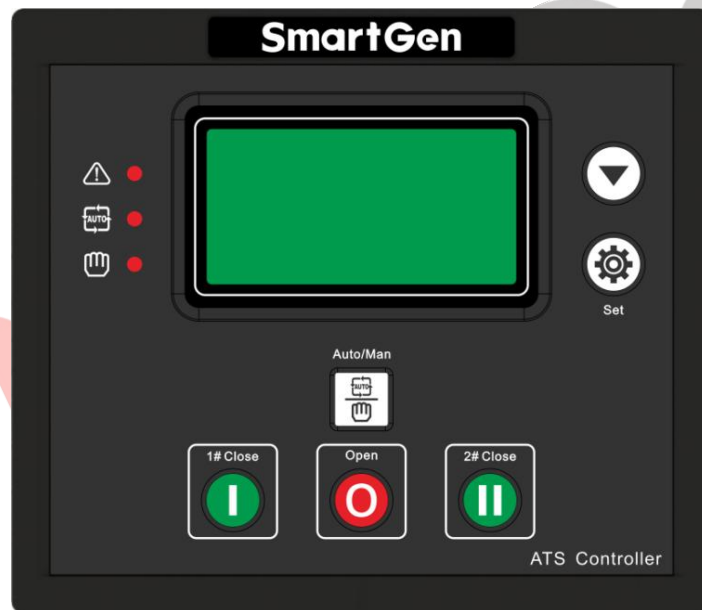

SmartGen
ideas for power

HAT560N Series
(HAT560N/HAT560NB)
ATS CONTROLLER
USER MANUAL



SMARTGEN (ZHENGZHOU) TECHNOLOGY CO., LTD.

CONTENT

1	OVERVIEW	4
2	PERFORMANCE AND CHARACTERISTICS	5
3	SPECIFICATION.....	6
4	OPERATING	7
4.1	OPERATION PANEL.....	7
4.2	KEY FUNCTION DESCRIPTION.....	7
5	LCD DISPLAY	8
5.1	MAIN SCREEN	8
5.2	MAIN MENU INTERFACE	9
6	PARAMETERS CONFIGURATION.....	10
6.1	PARAMETERS TABLE	11
6.2	INPUT/OUTPUT FUNCTION DESCRIPTION	14
7	EVENT LOG.....	16
8	TIMING START	17
9	COMMISSIONING	18
10	DATE AND TIME SETTING.....	19
11	LANGUAGE SETTING.....	19
12	CONTROLLER INFORMATION	19
13	ATS OPERATION	20
13.1	MANUAL OPERATION	20
13.2	AUTOMATIC OPERATION	20
13.3	ATS POWER SUPPLY	20
14	FAULT ALARM.....	21
15	COMMUNICATION CONFIGURATION.....	21
16	DESCRIPTION OF CONNECTING TERMINALS	22
17	TYPICAL WIRING DIAGRAM	24
18	INSTALLATION	28
19	FAULT FINDING	29

1 OVERVIEW

HAT560N series dual power ATS controller is an intelligent dual power supply module integrated with configurable function, automatic measurement, LCD display, and digital communication. It combines digitalization, intelligence and networking together, which realizes automation for measuring and control process, reducing artificial operation mistakes. It is the ideal product for dual power transfer.

HAT560N series dual power ATS controller is made with the microprocessor in the core, which can precisely measure 2-channel 3-phase/single phase voltages, make correct judgment for occurred voltage abnormal (over voltage, under voltage, loss of phase, over frequency, under frequency) and output discrete volt free control signals. This device is designed after considering various applications in ATS (auto transfer system onload), and can be used for specialized ATS switch, ATS with connector composed, and ATS made by air switch etc. It has compact structure, advanced circuits, simple wiring and high reliability, and can be widely used in electrical devices, automatic control and testing system of electric power, telecommunications, petroleum, coal, metallurgy, railways, municipal administration, intelligent building etc.

SmartGen

2 PERFORMANCE AND CHARACTERISTICS

- 1) System type can be set to: Mains (1#) & Generator (2#), Generator (1#) & Mains (2#), Mains (1#) & Mains (2#), Generator (1#) & Generator (2#);
- 2) 132x64 LCD with backlight, optional Chinese and English display, push-button operation;
- 3) Measure and display 2-channel 3 phase Voltage and Frequency:

1#	2#
Line voltage (Uab, Ubc, Uca)	Line voltage (Uab, Ubc, Uca)
Phase voltage (Ua, Ub, Uc)	Phase voltage (Ua, Ub, Uc)
Frequency Hz	Frequency Hz
- 4) Over/under voltage, loss of phase, reverse phase sequence, over/under frequency protection function;
- 5) Auto/Manual mode transfer function: in manual mode, it can force the switch to close or open;
- 6) All parameters are configurable. Two level password ensures authorized staff operation only.
- 7) On-load or Off-load commissioning operation on the genset can be set on site;
- 8) ATS Controller has function of automatic Re-closing.
- 9) Breaker close output can be set to pulse or steady output;
- 10) Applicable for ATS of one neutral position, two neutral position and non-position.
- 11) Design of 2 isolated neutral line.
- 12) Real-time clock (RTC).
- 13) Event log function allows to record 50 items circularly.
- 14) Scheduled start & stop generator function: running once monthly/weekly, and onload/offload running are configurable;
- 15) It can control two generators to work cyclically, and genset running time and crank rest time can also be set.
- 16) Optional AC system or DC system.
- 17) LINK communication port: has "remote control, remote measuring, remote communication" function with ModBus communication protocol; genset start, genset stop, ATS close/open can be controlled remotely;
- 18) Current controller status can be checked (digital input port, digital output port, over voltage, under voltage, over frequency, under frequency etc. circuit abnormal statuses);
- 19) Suitable for various wiring connection type (3 phase 4-wire, 3-phase 3-wires, single-phase 2-wire, and 2-phase 3-wire);
- 20) Modular design, self extinguishing ABS plastic shell, pluggable terminal, built-in mounting, compact structure with easy installation.

Table 2 HAT560N Series Model and Function Distinguish

Type	Function		
	DC Power Supply	AC Power Supply	AC Current/Power
HAT560N	√	×	×
HAT560NB	√	√ (LN220V)	×

3 SPECIFICATION

Table 3 Technical Parameters

Items	Contents		
Operating Voltage	1. DC 8.0V~35.0V continuous 2. AC170V~277V, AC power L1N1/L2N2 supply		
Power Consumption	<3W (Standby mode: ≤2W)		
AC Voltage Input	AC system	HAT560N	HAT560NB
	3P4W (ph-N)	AC30V~AC360V	AC170V~AC277V
	3P3W (ph-ph)	AC60V~AC620V	N/A
	1P2W (ph-N)	AC30V~AC360V	AC170V~AC277V
	2P3W (ph-N)	AC30V~AC360V	AC170V~AC277V
Rated Frequency	50/60Hz		
Close Relay Output	16A AC250V Volts free output		
Auxiliary Relay Output 1	7A AC250V Volts free output		
Auxiliary Relay Output 2	7A AC250V Volts free output		
Auxiliary Relay Output 3	16A AC250V Volts free output		
Auxiliary Relay Output 4	16A AC250V Volts free output		
Digital Input	GND connected is active.		
Communication	LINK interface, MODBUS Protocol		
Case Dimensions	139mmx120mmx48mm		
Panel Cutout	130mmx111mm		
Working Conditions	Temperature: (-25~+70)°C; Humidity: (20~93)%RH		
Storage Condition	Temperature: (-25~+70)°C		
Protection Level	IP55 Gasket: when there is waterproof gasket installed between controller and the control panel;		
Insulation Strength	Apply AC2.2kV voltage between high voltage terminal and low voltage terminal and the leakage current is not more than 3mA within 1min.		
Weight	0.62kg		

4 OPERATING

4.1 OPERATION PANEL

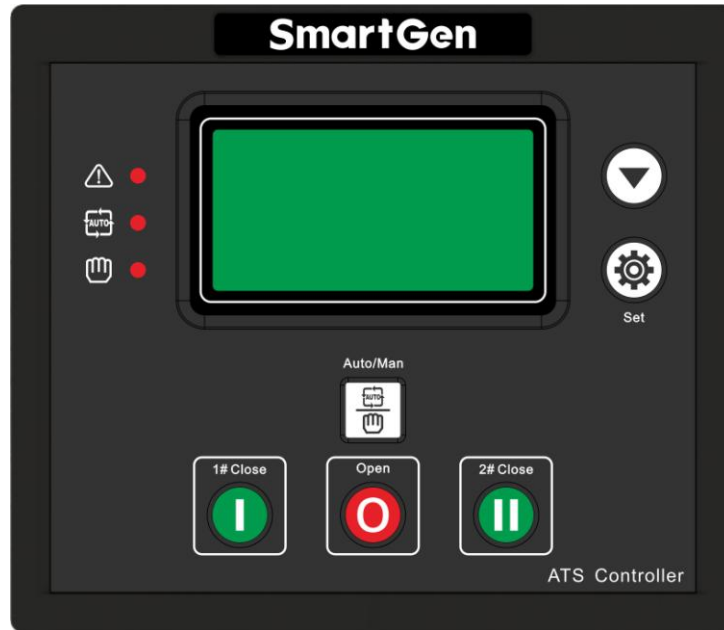

Fig. 1 Front Panel

4.2 KEY FUNCTION DESCRIPTION

Table 4 Key Function Description

Key	Function	Description
	I# Manual Close	In manual mode, press and 1# power connects with load.
	Open	In manual mode, press and disconnect 1# or 2# load.
	II# Manual Close	In manual mode, press and 2# power connects with load.
	Manual/Auto Set	Press and controller can be set to Manual or Auto mode.
	Menu/Confirm	Press and enter menu interface; press for longer and exit from current operation and return to main screen; For controller fault alarms, press for 3s, and alarms can be cleared.
	Screen Scroll/ Decrease	Transfer display interface; Value decrease key for adjusting parameters in parameter setting page; Press for 3s, LCD backlight shall flash for once and enter backlight always on mode; and press again for 3s, LCD backlight is off and recovers to normal display mode.

5 LCD DISPLAY

5.1 MAIN SCREEN



<p>U1(L-L) 380 380 380V U2(L-L) 380 380 380V F1 50.0Hz F2 50.0Hz Present Status: MANUAL </p>	<p>This screen shows: 1#/2# line voltage (L1-L2, L2-L3, and L3-L1), frequency, controller working status, close and load information.</p>
<p>U1(L-N) 220 220 220V U2(L-N) 220 220 220V 2016-06-27 (1) 09:43:36 Present Status: MANUAL </p>	<p>This screen shows: 1#/2# 3 phase Voltage (L-N), real-time clock, controller working status, close load information.</p>
<p>1# Under Volt 2# Volt normal Gens Start signal Out Present Status: AUTO </p>	<p>First line: 1# working status Second line: 2# working status Third line: other working status Fourth line: alarm type and information. Fifth line: close and load information</p>

Table 5 #1 Status (upper to lower)

No.	Item	Type	Description
1	1# Gens Alarm	Alarm	When 1# genset failure occurs, this will display.
2	1# Fail to Close	Alarm	When 1# close failure occurs, this will display.
3	1# Fail to Open	Alarm	When 1# open failure occurs, this will display.
4	1# Over Voltage	Indication	When 1# power supply voltage has exceeded the set value, this will display.
5	1# Loss of Phase	Indication	Loss of any phase of A, B and C.
6	1# Over Freq	Indication	When 1# power supply frequency is higher than the set value, this will display.
7	1# Under Freq	Indication	When 1# power supply frequency has fallen below the set value, this will display.
8	1# Under Volt	Indication	When 1# power supply voltage has fallen below the set value, this will display.
9	1# Phase Sequence Wrong	Warning	Phase sequence is not A-B-C.
10	1# Volt Normal	Indication	1# power supply voltage is within the setting range.

Table 6 #2 Status (upper to lower)

No.	Item	Type	Description
1	2# Gens Alarm	Alarm	When 2# genset failure occurs, this will display.
2	2# Fail to Close	Alarm	When 2# close failure occurs, this will display.
3	2# Fail to Open	Alarm	When 2# open failure occurs, this will display.
4	2# Over Voltage	Indication	When 2# power supply voltage has exceeded the setting value, this will display.
5	2# Loss of Phase	Indication	Loss of any phase of A, B and C.
6	2# Over Freq	Indication	When 2# power supply frequency is higher than the set value, this will display.
7	2# Under Freq	Indication	When 2# power supply frequency has fallen below the set value, this will display.
8	2# Under Volt	Indication	When 2# power supply voltage has fallen below the set value, this will display.
9	2# Phase Sequence Wrong	Warning	Phase sequence is not A-B-C.
10	2# Volt Normal	Indication	2# power supply voltage is within the setting range.

Table 7 Other Status (upper to lower)

No.	Item	Type	Description
1	Trip Alarm	Alarm	Trip alarm input is active.
2	Breaking Compulsorily	Warning	Breaking compulsorily input is active.
3	Gens Start Out	Indication	Start input is active.
4	Remote Start Input	Indication	This input is active when start the genset circularly.



NOTES:

Alarm: When alarm occurs, indicators will flash and this alarm signal won't be removed until  is pressed for 3s;



Warning: When warning alarm occurs, alarm indicator will flash while it will extinguish when warning alarm is inactive. That is to say, warning alarm is not latched.



5.2 MAIN MENU INTERFACE

In the main screen, press  key and enter into the main menu interface.



1. Exit 2. Parameters Set 3. Event Log 4. Scheduled Start 5. Commissioning	Press  key to choose parameters (the current line was highlighted with black) and then press  key to confirm, then enter into the corresponding display screen.
4. Scheduled Start 5. Commissioning 6. Date/Time 7. Language 6. Information	



6 PARAMETERS CONFIGURATION



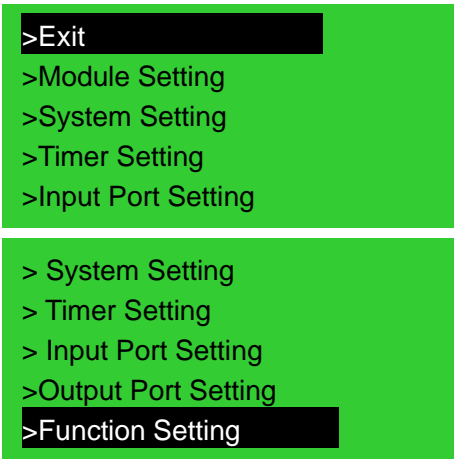

In the main interface, press  key, choose **2.Parameters setting** and press  again to enter parameter password confirmation interface.

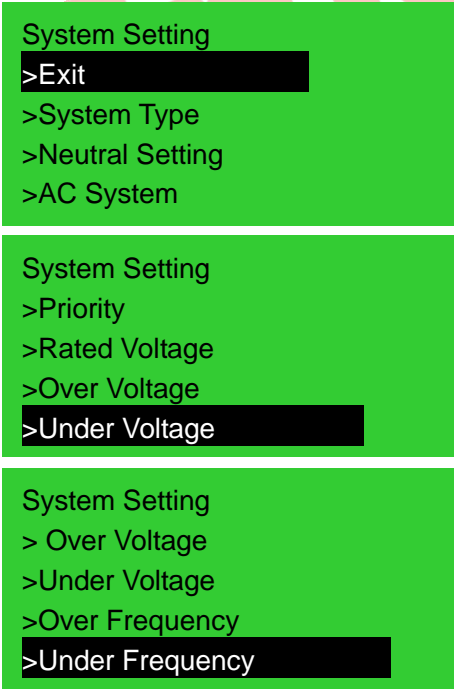
Press  and input the corresponding password 0~9; press  key to right move the bit, at fifth bit press  key to check password. If password is correct, it enters parameter setting interface, otherwise, it exits directly. Factory default password is **00318**.

▲NOTE: In parameter setting page, press  longer and it can exit parameter setting menu directly and return to main interface.

 <p>>Exit >Module Setting >System Setting >Timer Setting >Input Port Setting</p> <hr/> <p>> System Setting > Timer Setting > Input Port Setting >Output Port Setting >Function Setting</p>	<p>Press  key to choose parameters (the current line was highlighted with black) and then press  key to confirm, and it can enter into the corresponding display screen. Select >Exit and it will return to main display.</p>
--	---

 <p>System Setting >Exit >System Type >Neutral Setting >AC System</p> <hr/> <p>System Setting >Priority >Rated Voltage >Over Voltage >Under Voltage</p> <hr/> <p>System Setting > Over Voltage >Under Voltage >Over Frequency >Under Frequency</p>	<p>Press  key to choose parameters (the current line was highlighted with black) and then press  key to confirm, and it can enter into the corresponding display screen. Select >Exit and it will return to previous menu.</p>
---	--

Under Voltage Set Value: 00080% Return Value: 00085%	Press  button and it can scroll screen in parameter setting; In current parameter setting screen, press  and it will enter into configuration status; the first digit of the current parameter was highlighted with black. Press  to adjust the set value; and press  key to right move the bit, at last bit press  key to confirm the set value. If the set value is in the range, the setting is successful; if it is out of the range, then the setting is invalid.
Under Voltage Set Value: 0 0080% Return Value: 00085%	

6.1 PARAMETERS TABLE

Table 8 Parameter Configuration Items

No.	Item	Range	Default	Description
01	1# Volts Normal Delay	(0-9999)s	10	The delay from #1 power abnormal to normal.
02	1# Volts Abnormal Delay	(0-9999)s	5	The delay from #1 power normal to abnormal.
03	2# Volts Normal Delay	(0-9999)s	10	The delay from #2 power abnormal to normal.
04	2# Volts Abnormal Delay	(0-9999)s	5	The delay from #2 power normal to abnormal.
05	Close Time	(0-20)s	5	Pulse time of close relay. When it is 0, means output constantly.
06	Open Time	(1-20)s	5	Pulse time of open relay.
07	Transfer Interval	(0-9999)s	1	Interval time from 1# switch off to 2# switch on; or from 2# switch off to 1# switch on.
08	Transfer Delay Expired	(0-20.0)s	0.0	The prolongation output time of the close relay after the module receives a closing signal.
09	Again Close Delay	(0-20.0)s	1.0	When the breaker fail to open for the first time, then the module will close for the second time and the Again Close Delay begins, after the delay has expired, if still failed to open the second time, the module will send out fail to open alarm.
10	Again Open Delay	(0-20.0)s	1.0	When the breaker fail to close for the first time, then the module will open for the second time and the Again Open Delay begins, after the delay has expired, if still failed to close the second time, the module will send out fail to close alarm.
11	Gen Start Delay	(0-9999)s	1	When voltage is abnormal, start delay begins, after the start delay has expired, start signal will be initiated.
12	Gen Stop Delay	(0-9999)s	5	After the genset is start, when voltage is normal, stop delay begins, after the stop delay has expired, stop signal will be initiated.

No.	Item	Range	Default	Description
13	Cycle Running Time	(1-1440)min	720	Gens cycle start running time.
14	Cycle Stop Time	(1-1440)min	720	Gens cycle stop time, that is to say it is the cycle stat running time of the other genset.
15	Genset Supply Delay	(0-9999)s	60	Failure identification time during genset cycle start running.
16	Rated Voltage	(100-600)V	230	AC system rated voltage.
17	Over Voltage	(100-150)%	120	Upper limit value of voltage; it is abnormal if the value has exceeded the set value.
18	Over Voltage Return	(100-150)%	115	Upper limit return value of voltage; it is normal only when the value has fallen below the set value.
19	Under voltage	(50-100)%	80	Lower limit value of voltage; it is abnormal if the value has fallen below the set value.
20	Under Voltage Return	(50-100)%	85	Lower limit return value of voltage; it is normal only when the value has fallen below the set value.
21	Over Frequency	(0.0-75.0)Hz	55.0	Upper limit value of frequency; it is abnormal if the value has exceeded the set value.
22	Over Frequency Return	(0.0-75.0)Hz	52.0	Upper limit return value of frequency; it is normal only when the value has fallen below the set value.
23	Under Frequency	(0.0-75.0)Hz	45.0	Lower limit value of frequency; it is abnormal if the value has fallen below the set value.
24	Under Frequency Return	(0.0-75.0)Hz	48.0	Lower limit return value of frequency; it is normal only when the value has fallen below the set value.
25	Module Address	(1-254)	1	Communication address
26	Password		00318	For entering advanced parameters setting.
27	System Type	(0-3)	0	1.1# Mains 2# Gens 2.1# Gens 2# Mains 3.1# Mains 2# Mains 4.1# Gens 2# Gens
28	Neutral Setting	(0-2)	1	1) Two Breaking; 2) One Breaking; 3) No Breaking.
29	AC System	(0-3)	0	0: 3P4W; 1: 3P3W; 2: Single Phase; 3: 2P3W.
30	Priority Select	(0-2)	0	1. 1# Priority; 2. 2# Priority; 3. NO Priority
31	Aux. Output 1	(0-31)	15	0 Not used
32	Aux. Output 2	(0-31)	12	1 Critical failure
33	Aux. Output 3	(0-31)	24	2 Fail of Transfer
34	Aux. Output 4	(0-31)	27	3 Warning output
				4 Alarm output(delay)
				5 1# Normal volt
				6 1# Abnormal volt



No.	Item	Range	Default	Description
				7 2# Normal volt 8 2# Abnormal volt 9 Reserved 10 Auto status output 11 Manual status output 12 Gens Start Output(N/O) 13 Gens Start Output(N/C) 14 1# Close output 15 1# Open output 16 2# Close output 17 2# Open output 18 Common Alarm output 19 Timing Commissioning 20 1# Close Status Output 21 2# Close Status Output 22 1# Gen Start Output(N/O) 23 2# Gen Start Output(N/O) 24 ATS Power A Phase 25 ATS Power B Phase 26 ATS Power C Phase 27 ATS Power N Phase 28 1# 2# Abnormal Volt 29 Reserved 30 Reserved 31 Reserved
35	Aux. Input 1	(0-13)	1	00.Not used
36	Aux. Input 2	(0-13)	0	01.Breaking compulsorily 02.Test off-load 03.Test on-load 04. Test Lamp 05. 1# Gens Alarm 06. 2# Gens Alarm 07. Remote start 08. Trip alarm 09. Reserved 10. Reserved 11. Reserved 12. Reserved 13. Reserved

6.2 INPUT/OUTPUT FUNCTION DESCRIPTION

Table 9 Input Port Function Description



Item	Description
0 Not used	Invalid
1 Breaking compulsorily	Applicable only for ATS with breakings; when it is active, ATS will transfer to 0 no matter in manual or auto mode;
2 Test off-load	Genset start is outputted and when Mains is normal, Gen doesn't close;
3 Test On-Load	Genset start is outputted and When Mains is normal, Gen closes;
4 Test lamp	LED indicators on the panel are all on; LCD backlight is on; LCD screen is dark;
5 1# Gens Alarm	1# genset fault occurs and it prohibits to start 1# genset (used for cyclical start);
6 2# Gens Alarm	2# genset fault occurs and it prohibits to start 2# genset (used for cyclical start);
7 Remote start	It is a must for genset start cyclically;
8 Trip alarm	
9 1#Priority	
10 2#Priority	
11 Reserved	
12 Reserved	
13 Reserved	

SmartGen

Table 10 Output Port Function Description

Item	Description
0 Not Used	Invalid
1 Critical Failure	It includes switch transfer failure;
2 Fail of Transfer	It includes 1# close failure, 1# open failure, 2# close failure, 2# open failure;
3 Warning Alarm Output	General warnings include 1# phase sequence wrong, 2# phase sequence wrong, and force to open;
4 Alarm Output (delay)	It outputs for 60s continuously for critical fault alarms;
5 1# Volts Normal	It will output when #1 voltage is normal.
6 1# Volts Abnormal	It will output when #1 voltage is abnormal.
7 2# Volts Normal	It will output when #2 voltages is normal.
8 2# Volts Abnormal	It will output when #2 voltages is abnormal.
9 Reserved	
10 Auto Status Output	It will output in auto mode.
11 Manual Status Output	It will output in manual mode.
12 Gens Start Output (N/O)	It outputs when genset starts (Relay closed).
13 Gens Start Output(N/C)	It outputs when genset starts (Relay opened).
14 1# Close Output	1# switch close signal output.
15 1# Open Output	1# switch open signal output as one breaking
16 2# Close Output	2# switch close signal output.
17 2# Open Output	2# switch open signal output.
18 Common Alarm Output	It includes critical failure alarm and warning alarm.
19 Timing Commissioning	Timing test function starts;
20 1# Close Status Output	#1 switch close status output.
21 2# Close Status Output	#2 switch close status output.
22 1#Gen Start Output (N/O)	It issues 1# oil engine start signal;
23 2#Gen Start Output (N/O)	It issues 2# oil engine start signal;
24 ATS Power A Phase	ATS power supply.
25 ATS Power B Phase	
26 ATS Power C Phase	
27 ATS Power N Phase	
28 1#2# Volts Abnormal	It outputs when 1# voltage and 2# voltage are abnormal.
29 Reserved	
30 Reserved	
31 Reserved	



7 EVENT LOG



In the main screen, press  key and select **3 Event log**, and then press  key again to confirm, the screen will show the event log information below:

```

1# Close          01/50
1# Volt normal
2# Under Volt
2016-06-27 08:43:14

Long pressing  to exit
  
```

Press  key to select the corresponding record, and press  key to enter into detailed information interface.

In the detailed information interface, press  key and it can display the record information circularly, which includes 1#/2# volt status, specific voltage, frequency and time and date. Press  and it can exit the current interface, while press  for a long time and it can return to main screen.

Event log information includes: event log type, 1# power supply, 2# power supply, 1# 3-phase voltage, 2# 3-phase voltage, 1# frequency, 2# frequency and the record date and time.

```

# 1 Close      01/50
1# Volt normal
2# Under Volt
2016-06-27   08:43:14
Long pressing  to exit

#1 Close      01/50
U1 L-N 220  220  220V
U2 L-N  0  100  220V
2016-06-27   08:43:14
Long pressing  to exit

#1 Close      01/50
F1 50.0Hz    F2 50.1Hz
2016-06-27   08:43:14
Long pressing  to exit
  
```

Table 11 Event Log Types

No.	Type	Description
1	1# Close	1# close signal output
2	2# Close	2# close signal output
3	1# Fail to Close	1# power supply cannot connect to load.
4	2# Fail to Close	2# power supply cannot connect to load.
5	1# Fail to Open	1# power supply cannot disconnect to load.
6	2# Fail to Open	2# power supply cannot disconnect to load.
7	Trip alarm	The input is active.
8	Breaking compulsorily	Breaking compulsorily input is active.

8 TIMING START

In the main screen, press  key and select **4 Time start**, and then pressing  key to confirm, the screen will show the timing start interface below:

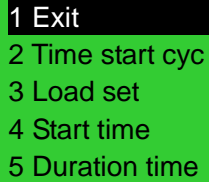
- 
- 1 Exit
 - 2 Time start cyc
 - 3 Load set
 - 4 Start time
 - 5 Duration time

Time start cycle: includes inhibit start; start the genset single time, weekly or monthly.



Load set: start the generator with load or without load.

Start time: the date and time of the genset starting.



Duration time: generator continuous run time can be set to the duration of maximum time for 99 hours and 59 minutes.

SmartGen

9 COMMISSIONING

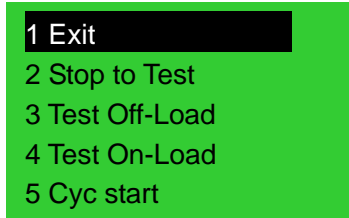
In the main screen, press  key and select **5 Commissioning**, and then press  key to confirm, the screen will show the commissioning interface as below:



Press  key to select corresponding function, and press  key to confirm.

TEST OFF-LOAD: It will send out a start signal immediately. After gen voltage is normal, if mains voltage is normal, the ATS will not act. If mains voltage is abnormal, ATS will transfer the load to generator. When mains volt recovers to normal, the ATS will transfer the load to mains. At this time the start generator signal still continuously outputs.

TEST ON-LOAD: It will send out a start generator signal immediately. After gen voltage is normal, the ATS will transfer the load to mains immediately regardless the mains is normal or not.

STOP TO TEST: When Commissioning has been chosen, and if this item is selected, genset start signal will disconnect immediately and it will stop TEST OFF-LOAD or TEST ON-LOAD operation.



CYCLE START: When this is chosen, oil engine start signal will output circularly according to master status. Circular output time can be set by the users. If oil engine fault occurs, it won't send start signal to the oil engine. If it transfers to manual mode, it will keep current status and stop circular start time counting.

Requirements needed:



1. In automatic mode.
2. Set output to 1# Oil Engine start output (N/O Output) and 2 # Oil Engine start output (N/O Output).
3. Set input to remote start input.
4. <Cycle running time> and <Cycle stop time> should be programmed.
5. Set the system type as 1# Gens & 2# Gens.
6. Set proper < Wait Running > time, and set default delay to 60s.

▲NOTE: In manual mode, if the commissioning input is active, generator start-signal will output immediately, but the ATS will not transfer automatically except for operation manually by pressing key on the front panel.

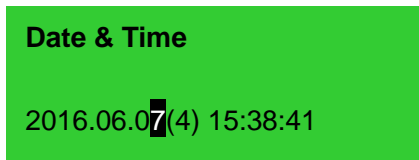

10 DATE AND TIME SETTING

In the main screen, press  key and select **6 Date & Time**, and then press  key again to confirm, the screen will show the Date & Time Set interface as below:





Press  to input the corresponding number 0-9; press  key to right move the bit, at the last bit press  key to update the date and time.

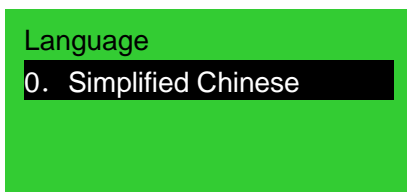

11 LANGUAGE SETTING

In the main screen, press  key and select **7 Language**, press  again to enter into language setting interface as below:



Press  to select the language and press  to confirm the setting.
Language option: Simplified Chinese/ English.

12 CONTROLLER INFORMATION

In the main screen, press  key and select **8 Controller information**, and then press  key again to enter controller information interface as below:

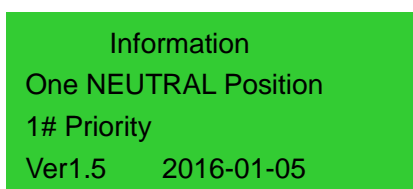





Display contents include current breaking positions setting, transfer priority choice and controller version and date.

Longer press  key and it will exit and return to main screen.

13 ATS OPERATION

13.1 MANUAL OPERATION

Press  and manual mode indicator is on, which means controller is in manual mode.

- 1) Press , 1# close relay outputs immediately, if 1# close input is active, the 1# power supply connects to load.
- 2) Press , 2# close relay outputs immediately, if 2# close input is active, the 2# power supply connects to load.
- 3) Press , 1#/2# open relay outputs immediately, if 1#/2# close input is inactive, the 1#/2# power supply disconnects with load.

▲NOTE: For the ATS without neutral position, it is invalid to press  key.

13.2 AUTOMATIC OPERATION

Auto mode indicator is on, which means controller is in auto mode. Controller can transfer to 1# load or 2# load automatically.

13.3 ATS POWER SUPPLY

ATS power supply is provided by the controller smartly. Only if there is one channel normal voltage can it ensure normal ATS power, and make it work normally.

Users shall choose power supply voltage (phase or line) based on ATS type. If it is phase voltage power, connect the phase voltage (A phase) of 1# and 2# with N/C Terminal 8 and N/O Terminal 10 of programmable port 3, connect N phase of 1# and 2# with N/C Terminal 13 and N/O Terminal 11 of programmable port 4, then connect the COM of programmable port 3 and programmable 4 with ATS power supply. At last power on the controller, and enter parameter configuration page; set port 3 to corresponding phase voltage "ATS power A phase", and set port 4 to "ATS power N phase". If ATS is supplied by line voltage, the set method is as above. You only need to change N phase to phase voltage connection and for port 4 you also need to change according to settings.

Fig. 2 Wiring Connection

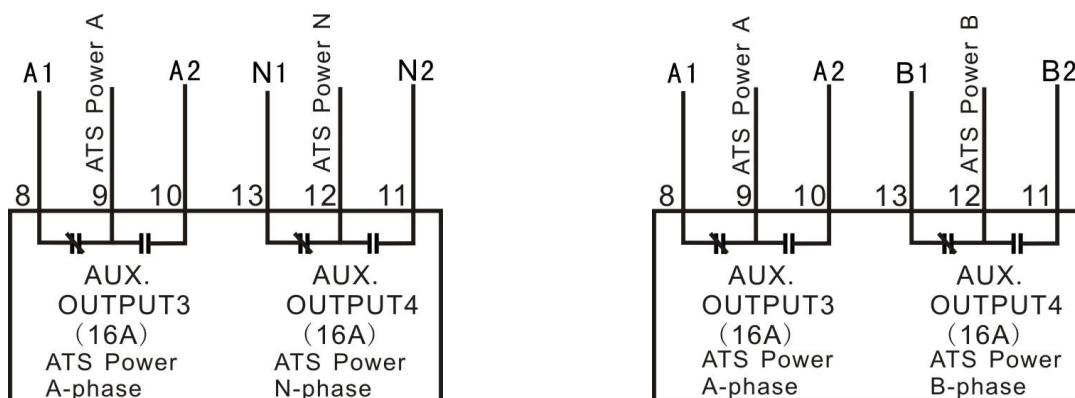

ATS phase voltage power supply

ATS line voltage power supply

▲NOTE: Normally Close (N/C) input voltage must come from 1# voltage.

14 FAULT ALARM

Table 12 Critical Failure

No.	Items	Type	Description
1	1# Gens Alarm	Alarm	1# genset failure occurs.
2	1# Fail to Close	Alarm	1# close failure occurs.
3	1# Fail to Open	Alarm	When 1# open failure occurs.
4	2# Gens Alarm	Alarm	2# genset failure occurs.
5	2# Fail to Close	Alarm	2# close failure occurs.
6	2# Fail to Open	Alarm	When 2# open failure occurs.
7	Trip alarm	Alarm	Trip alarm input is active.

Table 3 Warning Types

No.	Items	Type	Description
1	1# Phase Sequence Wrong	Warning	1# phase sequence is not A-B-C.
2	2# Phase Sequence Wrong	Warning	2# phase sequence is not A-B-C.
3	Breaking compulsorily	Warning	Breaking compulsorily input is active.

15 COMMUNICATION CONFIGURATION

HAT560N series controller has LINK communication port, which can provide a simple and practical dual power transfer management method for factories, telecom, industrial and civil buildings by using Modbus protocol via PC or system software and realize “remote control, remote measuring, remote communication” functions.

Communication Parameters:

Module address 1 (range: 1-254, User definable)

Baud rate 9600 bps

Data bit 8bit

Parity bit None

Stop bit 1 bit or 2-bits(can be set via PC)

▲NOTE: Select DC power supply to keep the continuity of communication.

16 DESCRIPTION OF CONNECTING TERMINALS

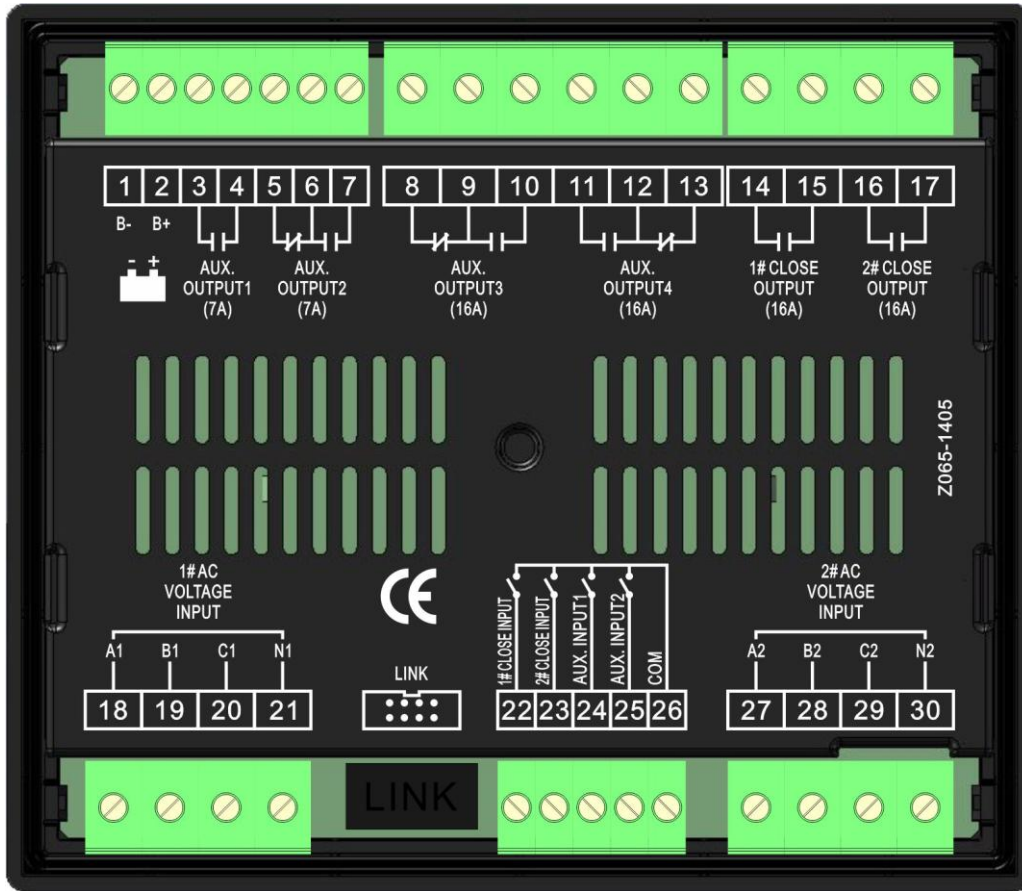

Fig. 3 Back Panel

Table 14 Terminal Function Description

No.	Functions	Description		Remark
1	B-	Connects with negative of starter battery.		DC input B-
2	B+	Connects with positive of starter battery.		DC(8-35)V, controller power supply
3	Aux. output 1	Default: 1# open output		Relay contact output; Volts free; Rated 7A
4				
5	Aux. output 2	N/C	Default: oil engine start (N/O)	Relay contact output; Volts free; Rated 7A
6		COM		
7		N/O		
8	Aux. output 3	N/C	Default: ATS Power A phase	Relay contact output; Volts free; Rated 16A
9		COM		
10		N/O		
11	Aux. output 4	N/O	Default: ATS Power N	Relay contact output; Volts free; Rated 16A
12		COM		
13		N/C		
14	1# Close Output	Relay contact output; Volts free;		Relay contact output; Volts free; Rated 16A
15				
16	2# Close Output	Relay contact output; Volts free;		Relay contact output; Volts free; Rated 16A
17				
18	A1	1# AC System 3P4W voltage input		For single phase, only connect A1, N1
19	B1			
20	C1			
21	N1			
22	1# Close Input	Detect 1# ATS close status. Auxiliary contact input.		Ground connected is active.
23	2# Close Input	Detect 2# ATS close status. Auxiliary contact input.		Ground connected is active.
24	Aux. Input 1	User-defined.		Ground connected is active.
25	Aux. Input 2	User-defined.		Ground connected is active.
26	COM	GND		
27	A2	2# AC 3P4W voltage input		For single phase, only connect A2, N2
28	B2			
29	C2			
30	N2			
LINK	Communication port	Used for PC communication/ software updating.		

17 TYPICAL WIRING DIAGRAM

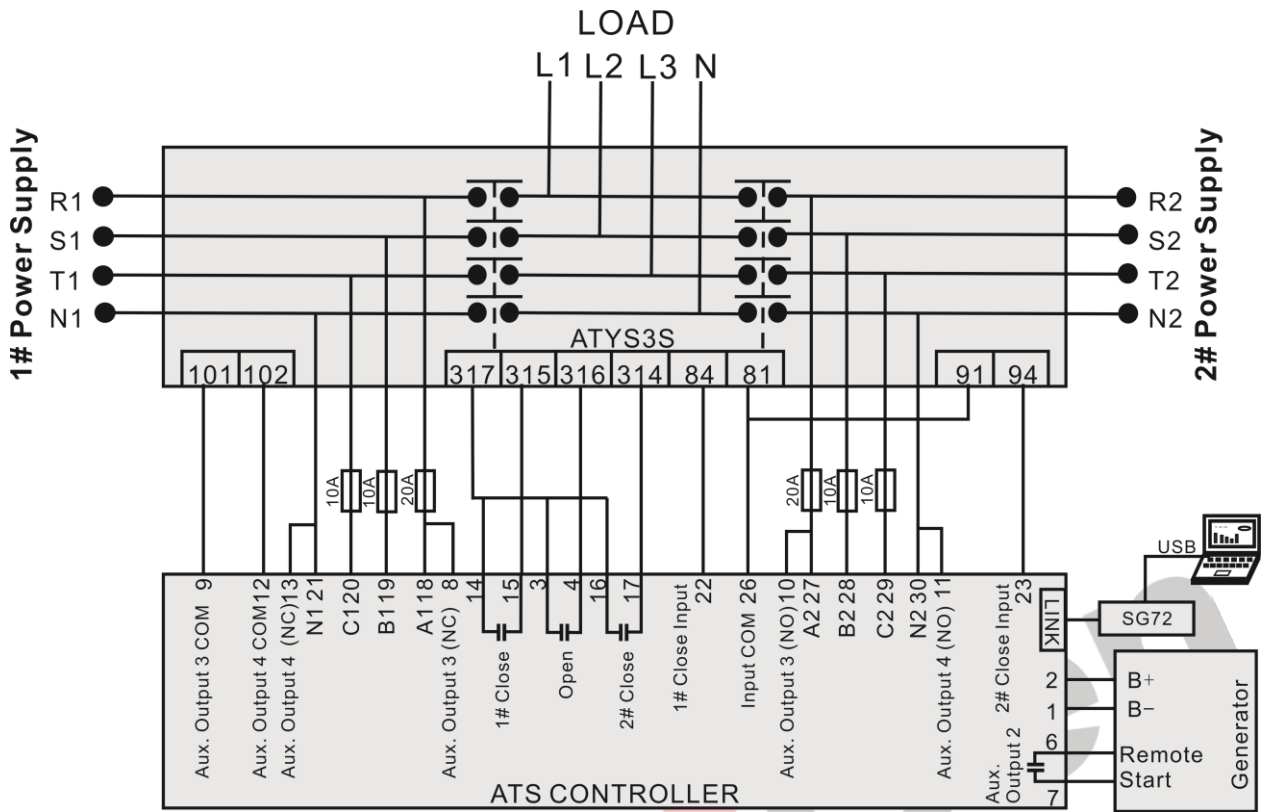

Fig. 4 ATYS3S Application Diagram

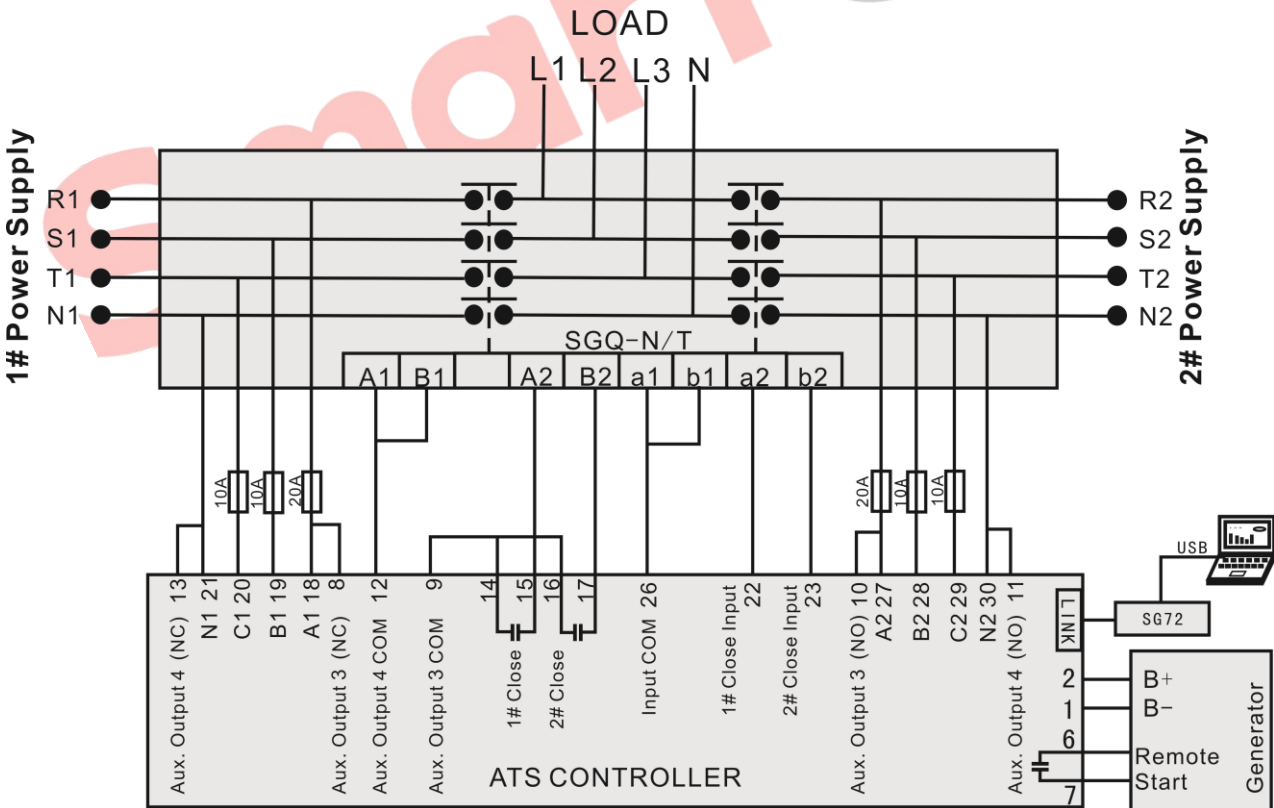

Fig. 5 SGQ-N/T Application Diagram

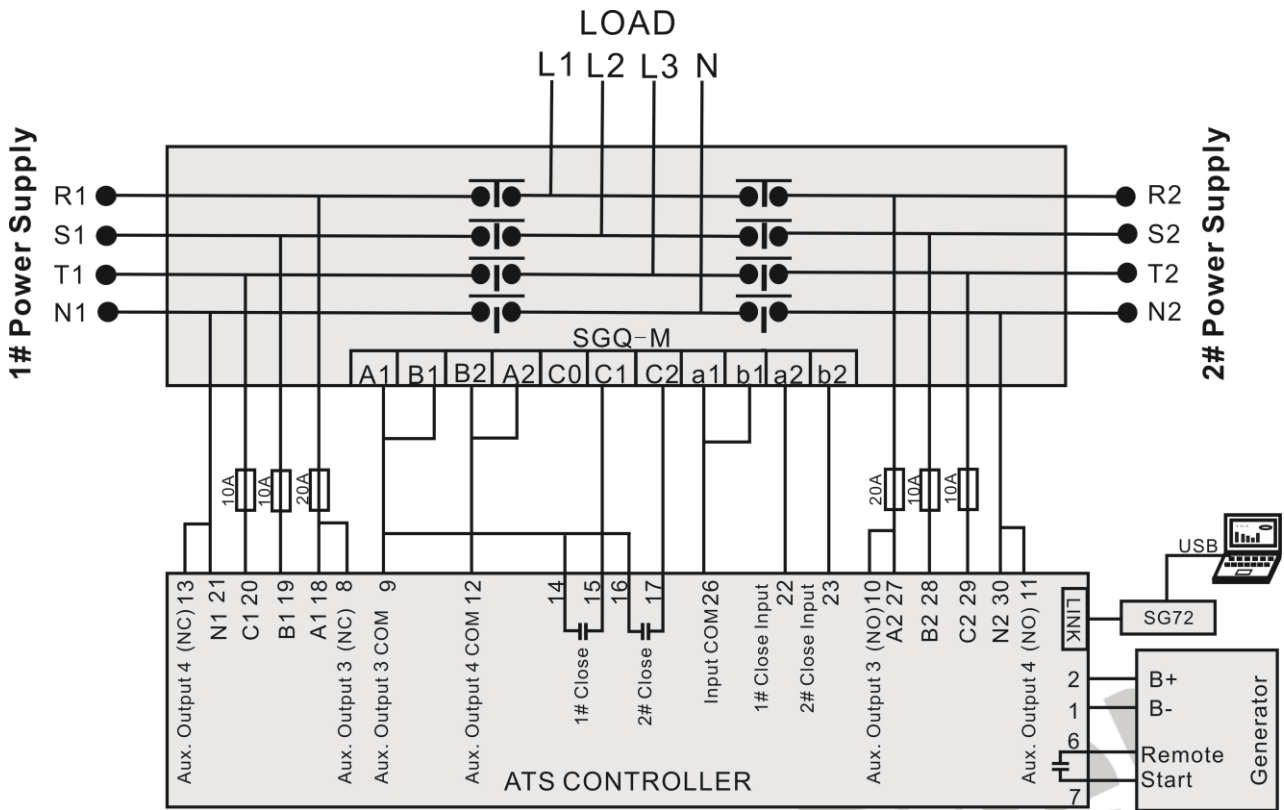

Fig. 6 SGQ-M Application Diagram

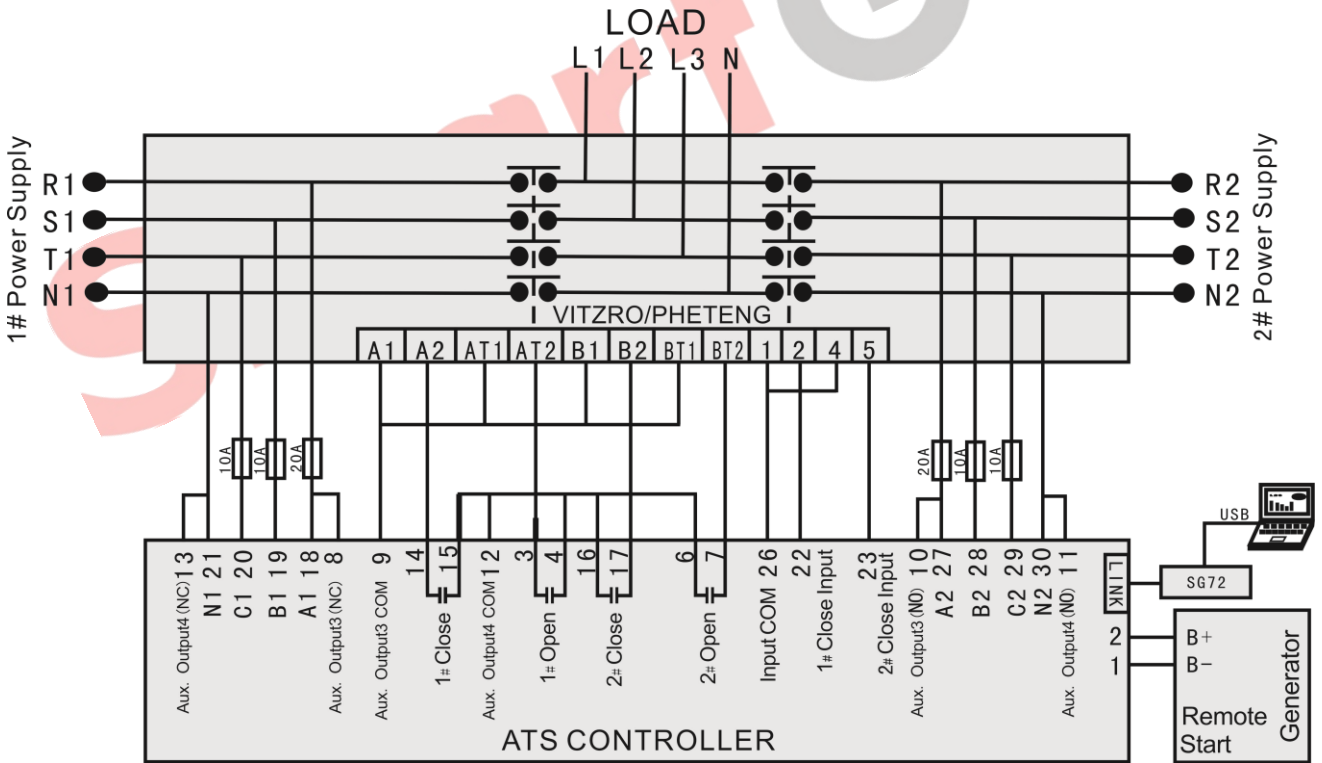

Fig. 7 VITZRO/PHETENG Application Diagram

- NOTE:** Set auxiliary output 1 as: 15: 1# Open Output
 Set auxiliary output 2 as: 17: 2# Open Output
 Set auxiliary output 3 as: 24: ATS power A-phase
 Set auxiliary output 4 as: 27: ATS power N-phase

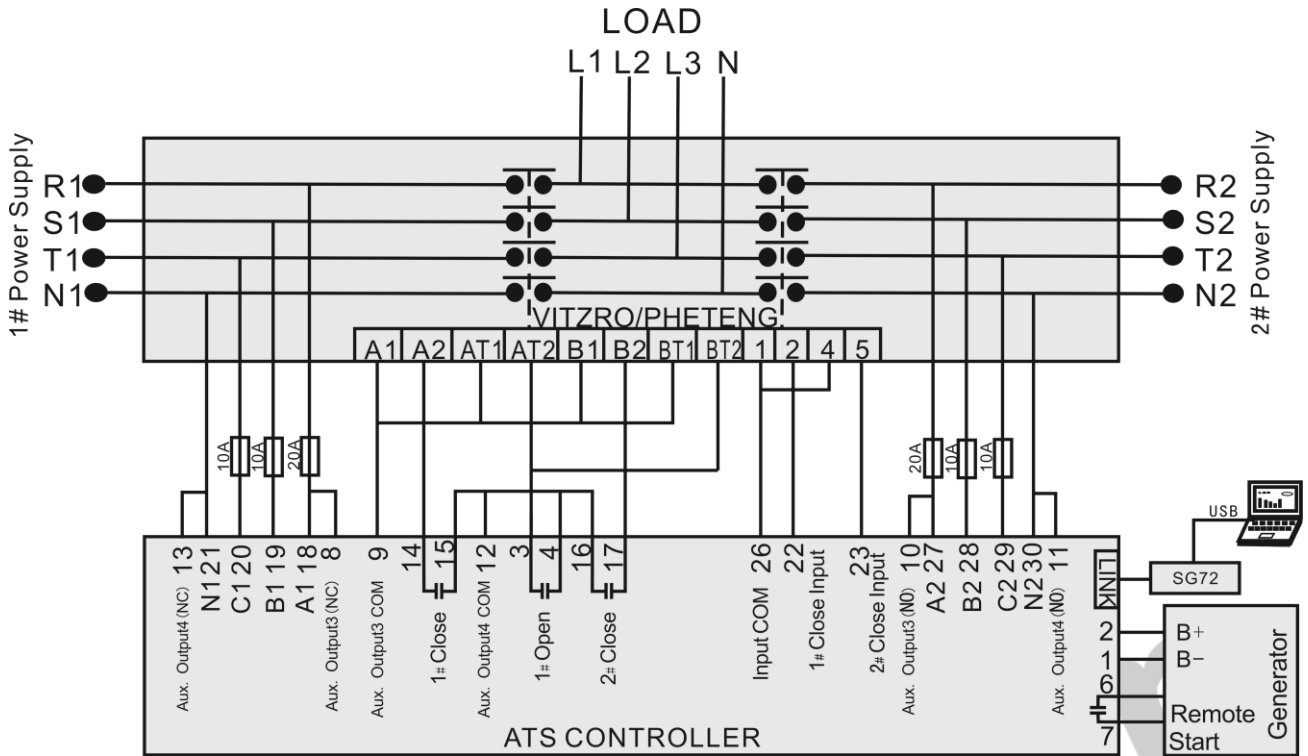

Fig. 8 VITZRO/PHE TENG (Generator Start Control)

- NOTE:** Set auxiliary output 1 as: 15: 1# Open Output
 Set auxiliary output 2 as: 12: Gen Start Output (N/O)
 Set auxiliary output 3 as: 24: ATS power A-phase
 Set auxiliary output 4 as: 27: ATS power N-phase

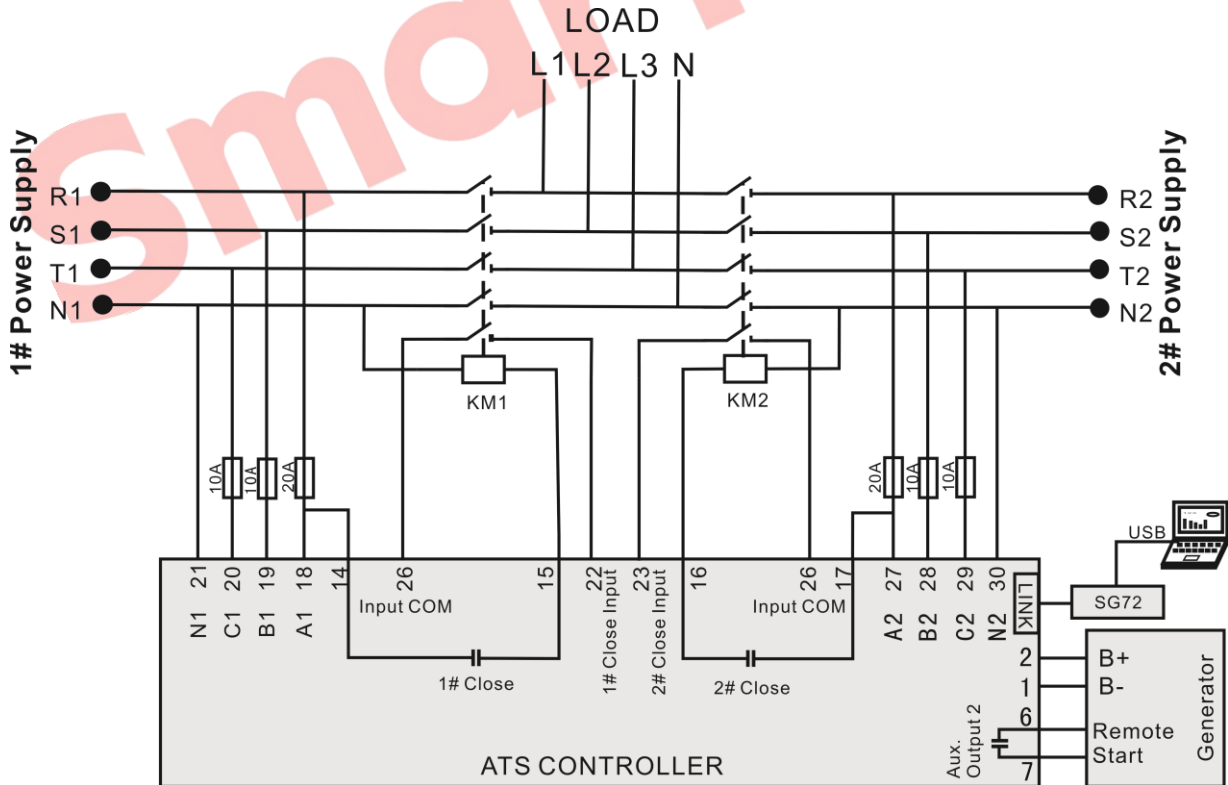

Fig. 9 Contactor Wiring Diagram

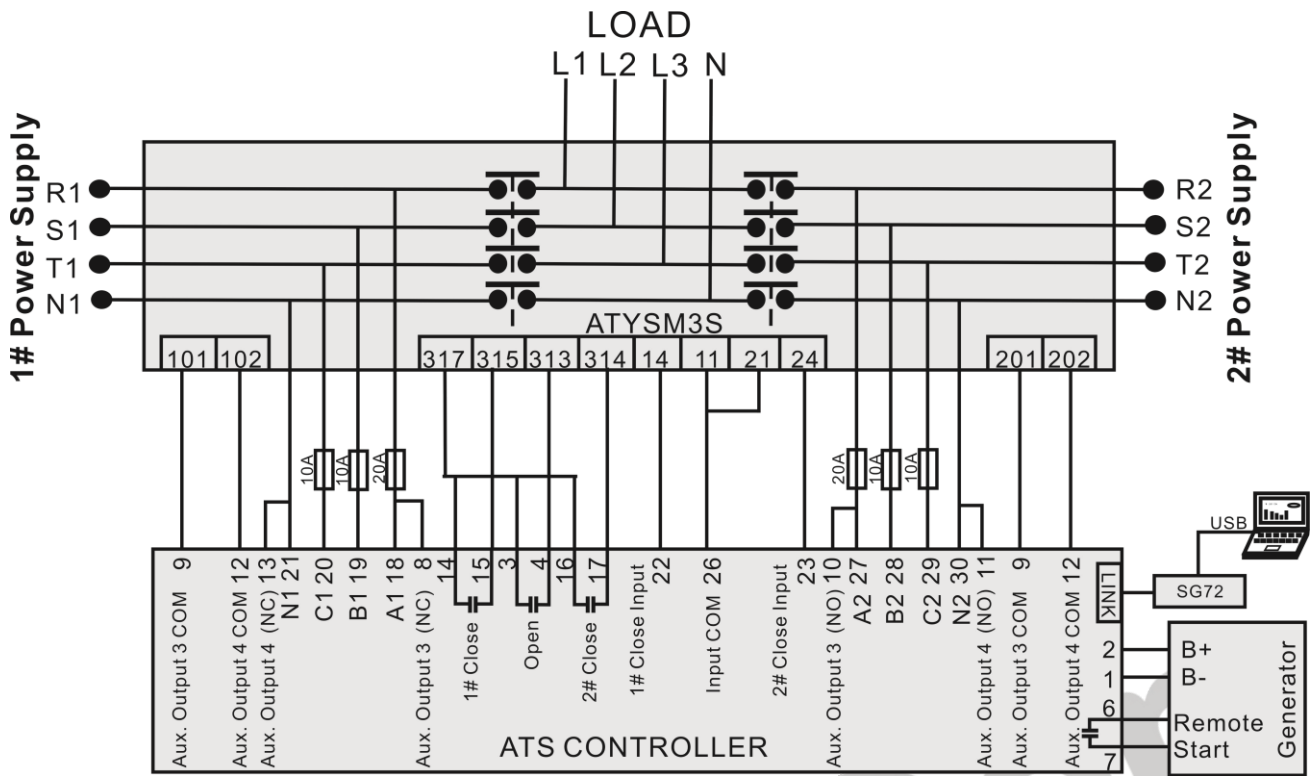

Fig. 10 ATYSM3S Wiring Diagram

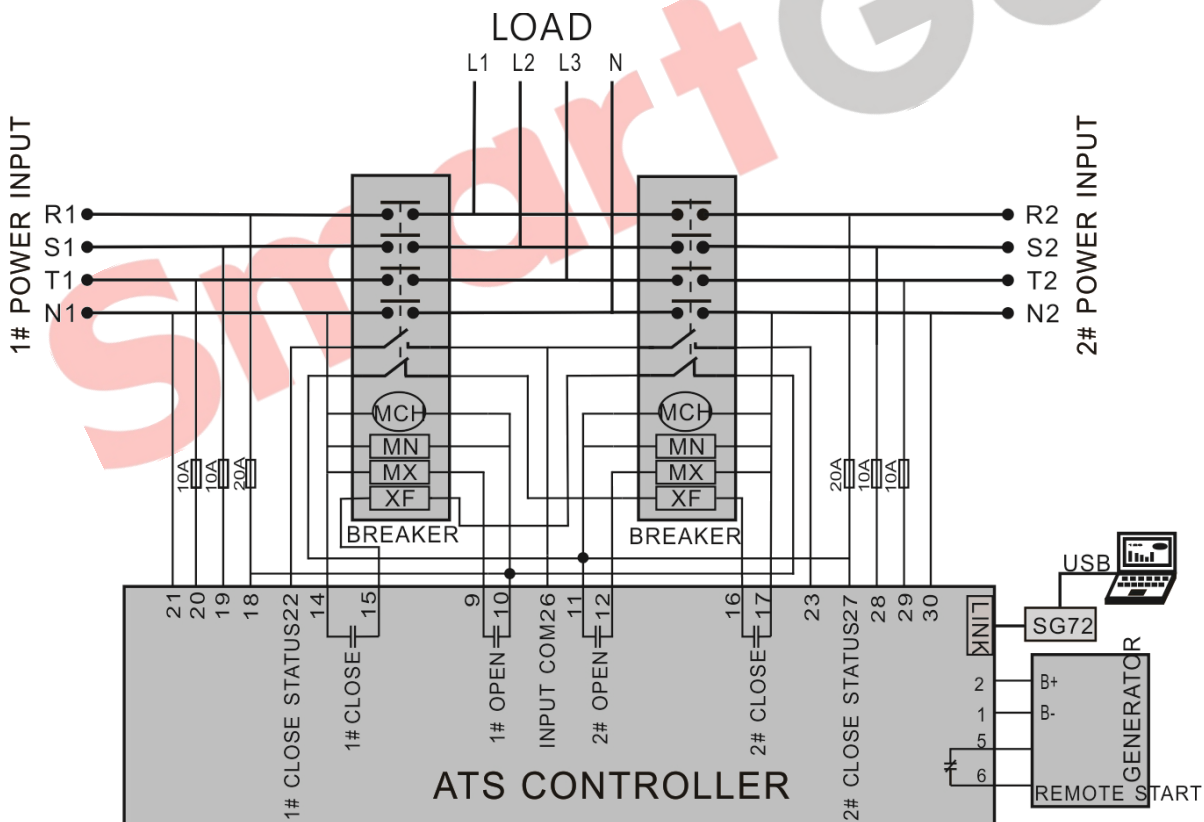

Fig. 11 Breaker Application Diagram

MCH: Energy Storage Motor; MN: Under Voltage Trip; MX: Open Coil; XF: Close Coil

- ▲NOTE: Set Aux. output 3 as 15: 1# open output
- Set Aux. output 4 as 17: 2# open output
- Set Aux. output 2 as 12: oil engine start N/C output

▲NOTE: Choose fuse capacity based on on-site actual power consumption and do not take the fuse in the diagram as

standard; if there is not DC supply, motor start control chooses replay N/C output. For ACB application please refer to breaker application diagram, and switch trip must connect with controller input in usage.

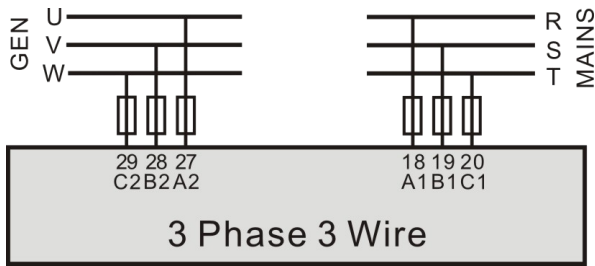

Fig. 12 3P3W Wiring Connection (take 1#Mains 2#Gens as an example)

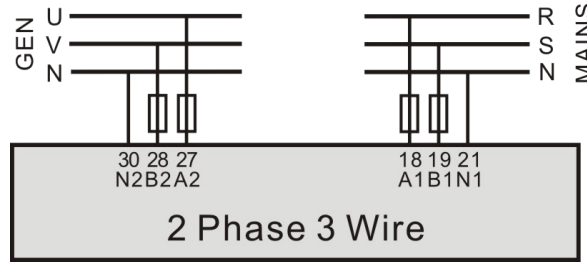

Fig. 13 2-phase 3-wire Wiring Diagram (take 1#Mains 2#Gens as an example)

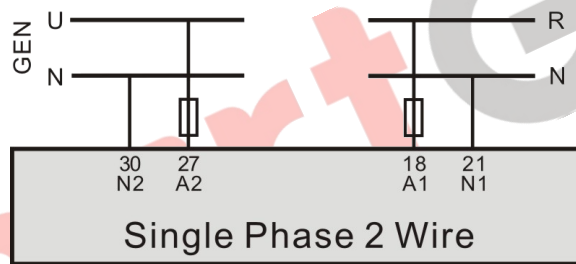

Fig. 14 Single phase 2-wire Wiring Diagram (take 1#Mains 2#Gens as an example)

18 INSTALLATION

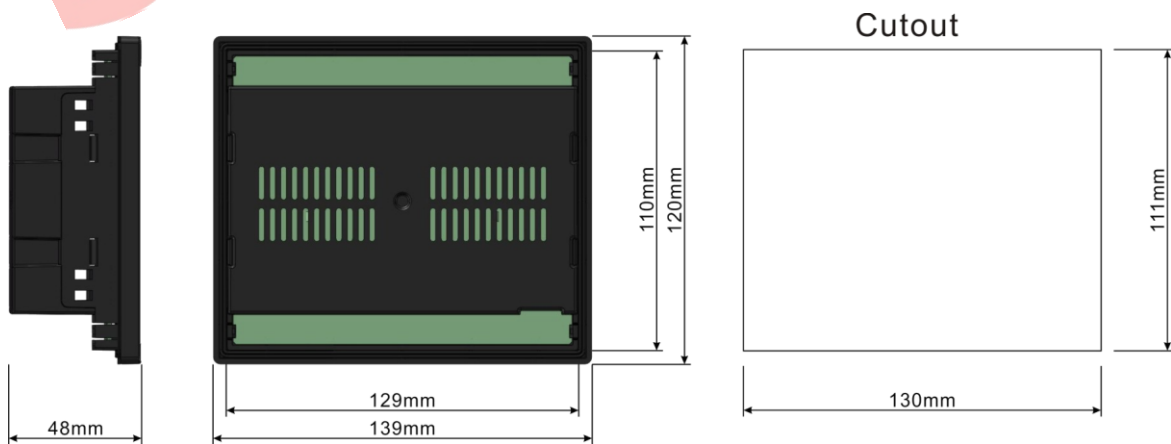

Fig. 15 Overall Dimensions and Cutout

19 FAULT FINDING

Table 15 Fault Finding

Symptom	Possible Solutions
Controller no response with power	Check battery voltage;
LINK communication failure	If SG72 module is fitted, check its connections. Check module address in parameters settings.
Auxiliary Output Error	Check auxiliary output connections, pay attention to normally open contact and normally close contact. Check the output settings in parameters settings.
Auxiliary Input Abnormal	Check whether aux. input port is GND connected when it's active, and it shall hung up when it is inactive. (▲NOTE: The input port will be possibly destroyed when connected with voltage.)
Genset running while ATS not transfer	Check ATS. Check the connection wirings between the controller and the ATS. Check ATS breaking is in accordance with the set breaking.